

Manual

Software SPECTRO3-ANA-Scope V2.0

(PC software for Microsoft® Windows® 7, 8, 10)

for color sensors of SPECTRO-3-ANA Series with internal temperature compensation and white light balancing

This manual describes the installation of the PC software for the SPECTRO-3-ANA color sensor. As a support for commissioning of the color sensor this manual explains the functional elements of the Windows® user interface.

The SPECTRO-3-ANA provides highly flexible signal acquisition. For example, the sensor can be operated in alternating-light mode (AC mode), which makes the sensor insensitive to extraneous light. It also can be set to constant-light mode (DC mode), which makes the sensor extremely fast. An OFF function turns off the integrated light source at the sensor and changes to DC operation. The sensor then can detect so-called "self-luminous objects". With the stepless adjustment of the integrated light source as well as the selectable gain of the receiver signal and an INTEGRAL function the sensor can be set to almost any surface or any "self-luminous object".

When the integrated light source of the SPECTRO-3-ANA color sensor is activated, the sensor detects the radiation that is diffusely reflected from the object. As a light source the SPECTRO-3 color sensor uses a LED with adjustable transmitter power. An integrated 3-fold receiver for the red, green, and blue content of the light that is reflected from the object, or the light that is emitted by a "self-luminous object", is used as a receiver.

The color sensors of the SPECTRO-3-ANA series can be taught up to 3 colors that are provided directly at the outputs, and up to 64 colors that are output by means of grouping. For each of these taught colors it is possible to set tolerances. In "X Y INT - 2D" or "s i M - 2D" mode these tolerances form a color cylinder in space. In "X Y INT - 3D" or "s i M - 3D" mode the tolerances form a color sphere in space. Color evaluation according to "s i M - 2D" is based on the lab calculation method. All modes can be used in combination with several operating modes such as "FIRST HIT" and "BEST HIT". Raw data are represented with 12 bit resolution.

As a special feature the sensor can be taught two completely independent parameter sets. Input IN0 can then be used to tell the sensor which parameter set it should work with.

Color detection either operates continuously or is started through an external PLC trigger signal. The respective detected color either is provided as a binary code at the 2 digital outputs or can be sent directly to the outputs, if only up to 2 colors are to be detected.

In addition to the 2 digital outputs there also are 3 analog outputs that either provide the red, green, and blue components or the calculated color coordinates (X, Y, INT or s, i, M) in values of 0-10V or 4-20mA.

Through input IN0 (green wire of the cab-las8/SPS cable) the color sensor can be taught up to 3 colors (max. 64 colors in group mode). For this purpose the corresponding evaluation mode must be set with the software.

Parameters and measurement values can be exchanged between a PC and the SPECTRO-3 color sensor through the serial RS232 interface. All the parameters for color detection also can be saved to the non-volatile EEPROM of the SPECTRO-3-ANA color sensor through this serial RS232 interface. When parameterisation is finished, the color sensor continues to operate with the current parameters in STAND-ALONE mode without a PC.

Possible firmware updates can be easily performed through the RS232 interface, even with the sensor system in installed condition. (→ cf. Annex „Firmware update via software Firmware Loader“).

The sensors of the SPECTRO-3-ANA series can be calibrated (white-light balancing). Balancing can be performed to any white surface. A ColorChecker™ table with 24 color fields is available as an alternative. White-light balancing or calibration can be performed to one of the white fields.

As a light source the SPECTRO-3-ANA UV color sensor uses a UV-LED (365 nm or 375 nm) with adjustable transmitter power to excite the luminescent marking. These UV sensors can be optimally adjusted to almost any luminescent colorant that can be excited in the long-wave UV range (365 nm or 375 nm). The UV sensors of the SPECTRO-3-ANA series also can be calibrated. Analogous to white-light balancing with color sensors, balancing of the SPECTRO-3-ANA UV sensors could be performed to any luminescent color marking.

0 Contents

	Page
1. Installation of the SPECTRO3-ANA-Scope software.....	3
2. Operation of the SPECTRO3-ANA-Scope software	4
2.1 Tab CONNECT	5
2.2 Tab PARA1, button SEND, GET, GO, STOP (parameterization, data exchange)	7
2.3 Tab PARA2 (color groups and hold time setting)	21
2.4 Tab TEACH (Teach Table).....	22
2.5 Tab GEN (color rows and color specifications)	26
2.6 Tab REC (data recording)	27
2.7 Tab CALIB.....	29
2.7.1 White light balancing	29
2.7.2 Offset calibration	32
2.8 Tab SCOPE	33
2.9. Graphic display elements	34
3. Short instructions for the operation of color sensors with software SPECTRO3-ANA-Scope.....	36
4. Operation of the TEMPCOMP-Scope software	40
5. External triggering of the SPECTRO-3-ANA color sensor	41
6. Connector assignment of the SPECTRO-3-ANA color sensor	42
7. RS232 communication protocol.....	43
A. Firmware update via software Firmware Loader	55

Shortcuts:

SEND	F9
GET	F10
GO	F11
STOP	F12

1. Installation of the SPECTRO3-ANA-Scope software

Hardware requirements for successful installation of the SPECTRO3-ANA-Scope software:

- Microsoft® Windows 7, 8, 10
- IBM PC AT or compatible
- VGA graphics
- Microsoft-compatible mouse
- Serial RS232 interface at the PC or USB slot or RJ45 connector
- Cable ***cab-las4/PC*** for the RS232 interface or ***cab-4/USB*** for USB slot or ***cab-4/ETH***

Please install the software as described below:

1. The software can be installed directly from the installation CD-ROM. To install the software, start the SETUP program in the SOFTWARE folder of the CD-ROM.
As an alternative the software also can be downloaded from our homepage.
2. The installation program displays a dialog and suggests to install the software in the C:\"FILENAME" directory on the hard disk. You may accept this suggestion with **OK** or **[ENTER]**, or you may change the path as desired. Installation is then performed automatically.
3. During the installation process a new program group for the software is created in the Windows Program Manager. In the program group an icon for starting the software is created automatically. When installation is successfully completed the installation program displays "Setup OK".
4. After successful installation the software can be started with a left mouse button double-click on the icon.

Windows® is a trademark of the Microsoft Corp.
VGA™ is a trademark of the International Business Machines Corp.

2. Operation of the SPECTRO3-ANA-Scope software

Please read this chapter first before you start to adjust and parameterise the SPECTRO-3-ANA color sensor.

When the SPECTRO3-ANA-Scope software is started, the following window appears on the Windows interface:

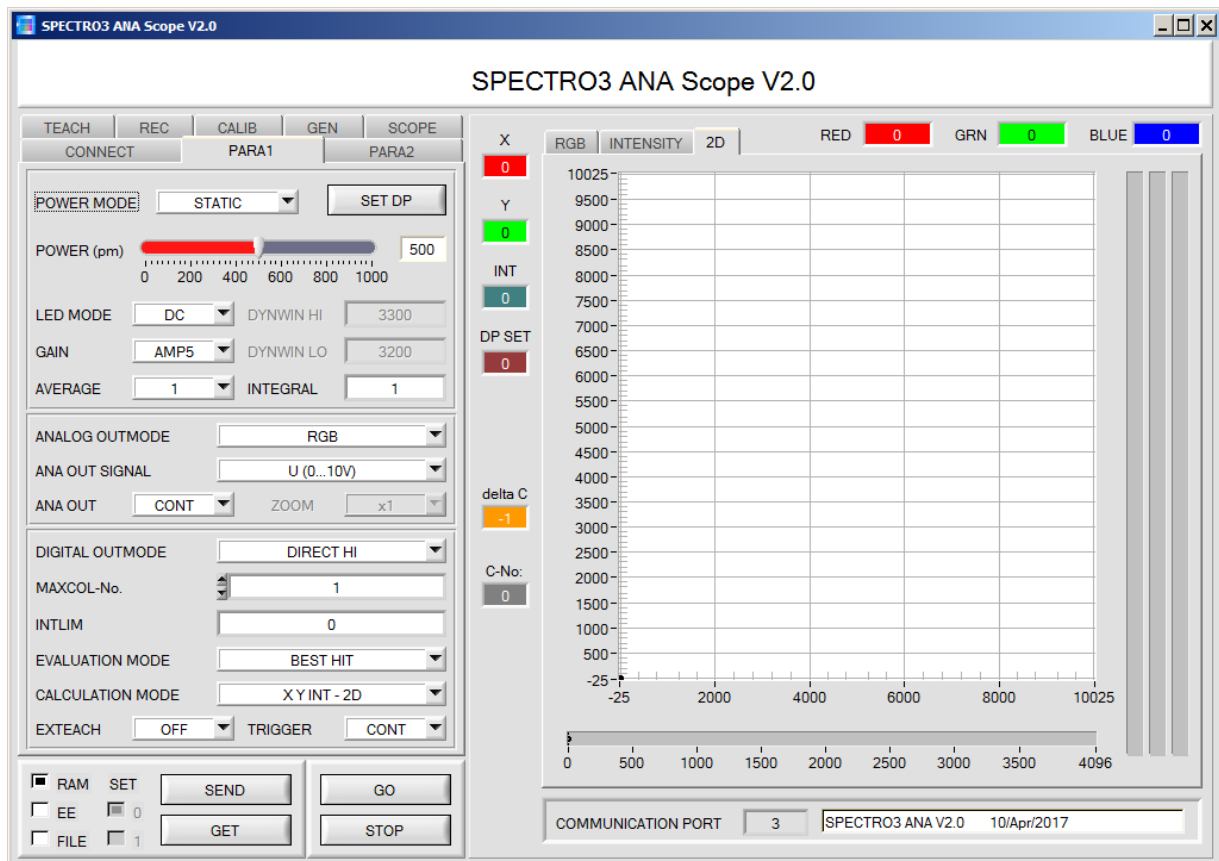

The window size and position will be the same as when the software was last closed. A double-click with the right mouse button e.g. under the minimise symbol places the window centrally in its original size.

If a connection is not established automatically, e.g. if no sensor is connected, the software can be run in OFFLINE mode. In offline mode it only is possible to exchange parameters with a file on a storage medium, which often is helpful for the purpose of analysing parameter files.

If a sensor is connected and a connection still cannot be established, either the SCOPE version (program at the PC) and the firmware version (program in the sensor) do not match, or the interface to the sensor must be correctly configured.

If different Scope and firmware versions should be the problem, please get the Scope version that matches the firmware from your supplier.

The interface configuration is described in the CONNECT tab chapter.

Pressing the right mouse button on an individual element will call up a short help text.

2.1 Tab CONNECT



The screenshot shows two windows for the 'CONNECT' tab. The top window is for RS232 communication, with fields for 'COMMUNICATION PROTOCOL' (RS232), 'SELECT COM PORT' (1), and 'SELECT BAUDRATE' (115200). It includes 'TRY TO CONNECT' and 'DISCONNECT' buttons, a status display showing 'Try to connect!', 'Firmware Version', 'Sensor: Type', and 'Serial number: xxxxxx', and buttons for 'ACCEPT SETTINGS', 'CHANGE BAUDRATE', and 'GEN. HW INFO FILE'. Below are fields for 'PANEL ID' and 'LANGUAGE' (ENGLISH). The bottom window is for TCP/IP communication, with fields for 'COMMUNICATION PROTOCOL' (TCP/IP), 'IP ADDRESS (xxx.xxx.xxx.xxx) OR HOST NAME' (192.168.2.246), and 'PORT NUMBER (Default 5000)' (5000).

CONNECT:

Pressing the **CONNECT** tab opens a window for selecting and configuring the interface.

The **COMMUNICATION PROTOCOL** function field is used for selecting either an **RS232** or a **TCP/IP** protocol.

If **RS232** is selected, a port from 1 to 256 can be selected with **SELECT COM PORT**, depending on which port the sensor is connected to. The sensor operates with a set baudrate that can be modified with **CHANGE BAUDRATE** (see below). The sensor and the user interface both must operate with the same baudrate.

At the user interface the baudrate is set with **SELECT BAUDRATE**. If after starting the software should not automatically establish a connection, the correct baudrate can be found with **SELECT BAUDRATE**.

If an adaptor is used, the **COM PORT** number can be determined by way of the hardware manager in the system control panel.

A click on the magnifier symbol opens a list with all the possible COM ports in the display.

An RS232 to Ethernet adaptor (**cab-4/ETH**) is needed if the sensor should communicate through a local network. With this adaptor a connection to the sensor can be established using the **TCP/IP** protocol.

Parameterisation of the **cab-4/ETH** adaptor (assigning of IP address, baudrate setting, ...) can be done with the **SensorFinder software** that is available free of charge on the internet.

In order to establish a connection to the adaptor, its IP address or HOST name must be entered in the field **IP ADDRESS (xxx.xxx.xxx.xxx) OR HOST NAME**. The DROP DOWN menu (down arrow) shows the last 10 IP addresses that were used. An address from this list can be directly selected by clicking on the respective item. The DROP DOWN list is saved and is thus always available when the software is closed.

The **PORT NUMBER** for the cab-4/ETH is 5000. This port number must not be changed.

When you press the **TRY TO CONNECT** button, the software tries to establish a connection with the set parameters. The communication status is shown in the display field. If the sensor answers with its FIRMWARE ID, the set connection type can be accepted by pressing **ACCEPT SETTINGS**. You will then be returned to the **PARA** tab. If you get a **TIMEOUT** message, the software could not establish a connection to the sensor. In this case please check if the interface cable is correctly connected, if the sensor is supplied with power, and if the set parameters are correct.

If a connection has been accepted by pressing **ACCEPT SETTINGS**, the software starts automatically with these settings when called the next time.

DISCONNECT disconnects the connection between sensor and PC. The software then switches to OFFLINE mode, where it is only possible to exchange parameters with a file on a storage medium.

Under **PANEL ID** a name can be entered that will be displayed at different points in the program window, and that will be recorded in different files (e.g. Record File) as well.

With the input field **LANGUAGE** a language can be set with which the individual controls are displayed on the surface. This also applies to the help function that is actuated with the right mouse button.

<p>Please note:</p>  <p>ATTENTION !</p>	<p>The stable function of the interface is a basic prerequisite for measured value transfer from the PC to the sensor.</p> <p>Due to the limited data transfer rate through the serial RS232 interface only slow changes of the raw signals at the sensor front end can be observed in the graphic output window of the PC.</p> <p>For maintaining maximum switching frequency at the sensor data communication with the PC must be stopped (press the STOP button).</p>
--	---

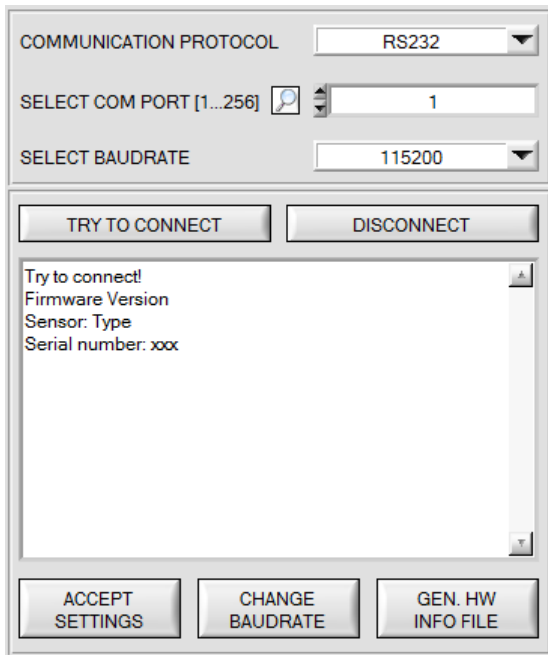

The baudrate for data transfer through the RS232 interface can be set by means of the **SELECT BAUDRATE** drop down menu and **CHANGE BAUDRATE** function field.

If the baudrate should be changed, a connection must first be established by clicking on **TRY TO CONNECT**. The **CHANGE BAUDRATE** button will then be active.

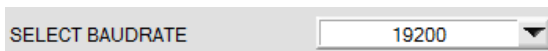

Now a new baudrate can be selected under **SELECT BAUDRATE**.

A click on **CHANGE BAUDRATE** sends the new baudrate information to the sensor.

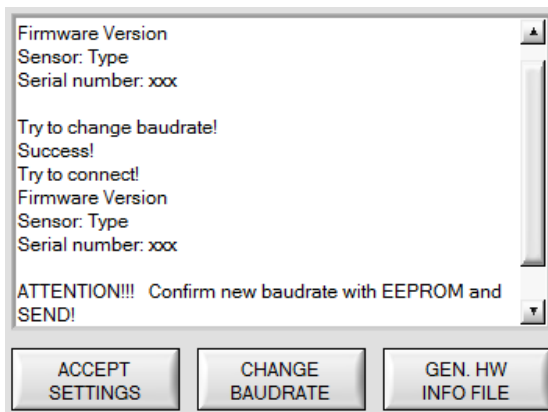
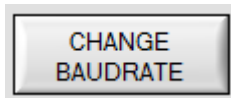

When the new baudrate information has been successfully sent, the sensor operates with the new baudrate. A window will pop up, prompting you to select **EEPROM** and then to press **SEND**. After a hardware reset the new baudrate only will be used when **EEPROM** and **SEND** have been pressed.

A click on **ACCEPT SETTINGS** saves the current interface settings, which will then be automatically set when the software is restarted.

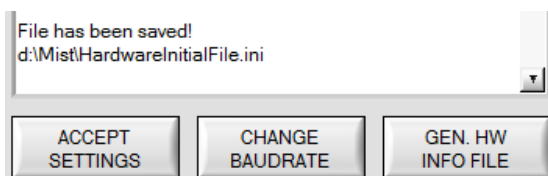

A click on the **GEN. HW INFO FILE** generates a file in which all the important sensor data are stored in encrypted form. This file can be sent to the manufacturer for diagnostic purposes.

2.2 Tab PARA1, button SEND, GET, GO, STOP

PARA1:

Pressing the **PARA1** tab opens a window for setting the sensor parameters.

ATTENTION!

A change of the parameter function groups only becomes effective at the sensor after actuation of the SEND button in the MEM function field!

SEND [F9]:

When the **SEND** button is clicked (or shortcut key button F9 is pressed), all the currently set parameters are transferred between PC and sensor. The target of the respective parameter transfer is determined by the selected button (**RAM**, **EEPROM**, or **FILE**).

GET [F10]:

The currently set values can be interrogated from the sensor by clicking on the **GET** button (or with shortcut key button F10). The source of data exchange is determined by the selected button (**RAM**, **EEPROM**, or **FILE**).

RAM:

After a click on the **SEND** button the current parameters are written into the **RAM** memory of the sensor, or they are read from the **RAM** by clicking on the **GET** button, i.e. these parameters are lost when the voltage at the sensor is switched off.

EEPROM:

After a click on the **SEND** button the current parameters are written into the non-volatile memory of the **EEPROM** in the sensor, or they are read from the **EEPROM** by clicking on the **GET** button, i.e. the parameters in the internal **EEPROM** are stored when the voltage at the sensor is switched off.

FILE:

After pressing **SEND**, the current parameters can be written to a selectable file on the hard disk. With **GET** parameters can be read from such a file. When the **SEND** or **GET** button is pressed, a dialog box opens for selecting the desired file.

GO [F11]:

A click on this button (or with shortcut key button F11) starts data transfer from the sensor to the PC through the serial RS232 interface.

SOURCE is used to select which signals should be shown in the displays and graphs.

STOP [F12]:

A click on this button (or with shortcut key button F12) stops data transfer from the sensor to the PC through the serial RS232 interface.

SET:

If you work with **TRIGGER=PARA**, two parameter sets can be saved for the sensor.

SET can then be used to select whether the current parameters on the user interface should be saved as parameter set 0 or parameter set 1 in the sensor.

Input IN0 is used to tell the sensor which parameter set it should work with.

SET only is active with **TRIGGER=PARA**.

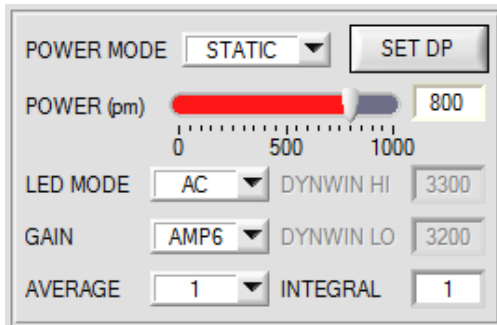

POWER MODE:

In this function field the operating mode of automatic power correction at the transmitter unit (transmitter LED) can be set.

STATIC:

The transmitter power is constantly kept at the value set with the **POWER [pm]** slider (recommended operation mode). The **POWER** can be set with the slider or by entering a value in the edit-box. A value of 1000 means full intensity at the transmitter unit, a value of 0 sets the lowest intensity at the transmitter.

DYNAMIC:

The LED transmitter power is dynamically controlled in accordance with the amount of radiation that is diffusely reflected from the object. By using the intensities measured at the receivers the automatic control circuit attempts to adjust the transmitter power in such a way that the dynamic range, which is determined by **DYN WIN LO** and **DYN WIN HI**, is not exceeded.

With **POWER MODE = DYNAMIC** the **POWER** value is used for intensity evaluation, and no longer the intensity that is calculated from the signals. One could also say that the transmitter intensity is evaluated, which corresponds with the **POWER** parameter. This is done because with **DYN WIN LO** and **HI** the sensor more or less is told to which intensity it should adjust itself. The power that flows into the sensor in order to achieve this intensity is much more meaningful than the intensity of the signal itself.

DOUBLE:

See **SET DP**

LED MODE:

This item serves for setting the control mode for the integrated light source of the sensor.

DC: In this mode the sensor operates extremely fast. Unfortunately the sensor is somewhat sensitive to extraneous light in DC mode, but if the extraneous light source does not directly shine into the sensor's receiver, the signal only is influenced to a very small extent.

AC: In this mode the sensor is insensitive to extraneous light, which is achieved by "modulating" the integrated light source, i.e. by turning the light on and off. The extraneous content in the signal is determined in off status and is simply subtracted from the on status.

OFF: The sensor's internal light source is turned off in DC mode by **POWER [pm] = 0**, the sensor can be used for so-called "self-luminous objects". Self-luminous objects are light sources that actively emit light (LEDs, lamps, etc.). In **OFF** mode the **POWER MODE** and **POWER** cannot be adjusted, and external teaching with **DYN1** is not possible.

GAIN:

This item is used for setting the gain of the receiver in 8 different gain stages (AMP1 to AMP8). **GAIN** should be set such that with a medium **POWER** value the sensor operates in its dynamic range (red, green, blue between 2750 and 3750).

In **AC** mode, **GAIN** directly influences the scan frequency. The current scan frequency is displayed in the **SCOPE** tab.

AVERAGE:

This function field is used for adjusting the number of scanning values (measurement values) over which the raw signal measured at the receiver is averaged. A higher **AVERAGE** default value reduces noise of the raw signals at the receiver unit and there will be a decrease of the maximal available switching frequency of the sensor

INTEGRAL:

This function field is used to set the number of scan values (measurement values) over which the raw signal measured at the receiver is summed up. This integral function allows the reliable detection even of extremely weak signals. A higher **INTEGRAL** value increases the noise of the raw signals of the receiver unit, and simultaneously decreases the maximum achievable switching frequency of the sensor.

INFO:

The **POWER** slider is only effective in the **POWER MODE = STATIC**.

DYN WIN LO and **DYN WIN HI** are only effective in **POWER MODE = DYNAMIC**.

SET DP:

If an application involves both very bright and very dark surfaces, and the sensor is set such that it is not in saturation at the bright surfaces, the dark surfaces frequently provide only a very low signal. Little variations with a very low signal lead to a large change in color space calculation. To minimise this effect, the sensor in **PMODE = DOUBLE** automatically switches back and forth between 2 **DOUBLE PARAMETER sets**. Set 2 must be parameterised such that the signal is maximally amplified. When the signal is too high (saturation), it automatically switches to set 1. The two parameter sets must be set at the sensor in advance.

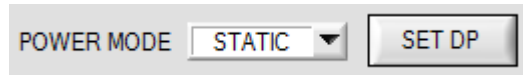

When you click on **SET DP** (Set Double Parameter) a window will open at the right side, where you can set two parameter sets. A parameter set is defined by **POWER, GAIN** and **INTEGRAL**

DOUBLE PARAMETER (DP)			
	POW	GAIN	INT
1	769	5	1
2	627	8	1

RGB VALUES			
	R	G	B
BRIGHT DP1	2997	2722	2381
DARK DP1	362	327	288
DARK DP2	2984	2718	2374

CORRECTION VALUES		
R	G	B
8.24	8.30	8.24

DOUBLE PARAMETER SET **2**

? DOUBLE PARAMETER
Push **START ASSISTANT** to adjust automatically proper **DOUBLE PARAMETERS**.
Follow these steps for manual setup:
Place the sensor to the bright target.
POWER MODE must be **STATIC**.
Push **GO** and adjust a proper **POWER, GAIN** and **INTEGRAL** value so that the highest value of **RED, GREEN, BLUE (RGB)** is approximately 3000.
Push **ASSIGN 1** to assign the **DOUBLE PARAMETER** and **RGB values** of the bright target to the tables.
Now place the darker target to the sensor.
Push **ASSIGN 2** to assign the **RGB values** of the dark target to the table.
After that adjust a proper **POWER, GAIN** and **INTEGRAL** value so that the highest value of **RGB** is approximately 3000.
Push **ASSIGN 3** to assign the **DOUBLE PARAMETER** and **RGB values** of the darker target to the tables.
Now select **POWER MODE=DOUBLE** and push **SEND** to send the parameters and correction values to the sensor.

Automatic setting of the DOUBLE parameter sets:

Pressing **START ASSISTANT** starts a menu guidance for automatically setting of the double parameter sets. Just follow the instructions.

Manual setting of the DOUBLE parameter sets:

Set **POWER MODE=STATIC**.

Place the brightest surface before the sensor, and select suitable **POWER, GAIN** and **INTEGRAL** values so that the brightest channel is at approx. 3000 digits.

Then click on **ASSIGN 1** to write the double parameters to row 1 in the **DP** table.

The **RGB values** are written to the **RGB VALUES** table.

Now place the darkest surface before the sensor.

The dark surface should be such that the lowest channel provides a signal higher than 100 digits.

Click on **ASSIGN 2**, and the **RGB values** are written to the **DARK DP1** row of the **RGB VALUES** table.

Now set **POWER, GAIN** and **INTEGRAL** such that the highest value is at approx. 3000.

Click on **ASSIGN 3** to write the double parameters to row 2 in the **DP** table, and the **RGB values** to the **RGB VALUES** table.

The correction values are calculated automatically and are written to the **CORRECTION VALUES** table.

INFO!

The double parameter sets only become active when you click on **SEND!**

The tables only are used to display the values. They cannot be edited.

The **DOUBLE PARAMETER SET** display shows which double parameter set the sensor currently uses.

When the display shows 0, the sensor operates with the settings in the **PARA1** tab.

ANALOG OUTMODE	RGB
ANA OUT SIGNAL	U (0...10V)
ANA OUT	CONT
ZOOM	x1

ANALOG OUTMODE:

This function field is used to determine the signals that the sensor provides at its analog outputs.

OFF: No analog signal is output.

R G B:

The **red, green, blue** signals are acquired with 12 bit resolution. The signals therefore may have values between 0 and 4095. At the respective analog outputs these values are provided in a 0 to 10V or 4 to 20mA range.

X Y INT

The **X, Y, INT** color coordinates are calculated scaled to 12 bit. The signals therefore may have values between 0 and 4095. At the respective analog outputs these values are provided in a 0 to 10V or 4 to 20mA range.

s i M:

The **s, i, M** color coordinates are calculated according to the L*a*b* color evaluation method. This calculation results in the following value ranges:
s: 0 to 10000 **i:** 0 to 4000 **M:** 0 to 1160
 The values for **s, i, M** are scaled to 12 bit and are provided at the respective analog outputs in a 0 to 10V or 4 to 20mA range.

RGB MM:

As long as input IN0 is HI, a maximum and minimum value is determined in the sensor for the red, green, and blue channel. Within the respective **MIN-MAX** ranges the analog signal for **R G B** is fully output (0-10V or 4-20mA). In the graph window the determined **MIN-MAX** values for the **R G B** channels are displayed under the **RGB** tab.

siM REF:

When input IN0 changes to HI, the current **s, i, M** are saved as 5V reference values. This means that when the respective current **s, i, M** value corresponds with the reference value, 5V or 12mA is output at the respective analog output. If the current value differs from the reference value, this difference is amplified by the **ZOOM** factor and provided at the respective analog output starting from 5V or 12mA.
Example: **ZOOM** = x4, **s**(reference) = 6000, **s**(current) = 6100 → difference = 100 (1 digit is approx. 2.44mV)
 The output value is: $5V + (100 \text{digit} * 4(\text{zoom}) * 2.44\text{mV}) = \text{approx. } 5.976V$.
 In the graph window the reference values for **s, i, M** are displayed in the **INTENSITY** tab.

Since the sensor only features one hardware input (IN0) this input possibility is not always available. For example, if the setting is **ANA OUT = RGB MM**, the input is needed for **MIN-MAX** searching and can therefore not be used for a controlled output of the analog signal. Function fields that are not available are either grayed out or deactivated.

ANA OUT SIGNAL:

Here you can set whether the analog signal is to be output as voltage (0 ... 10V) or current (4 ... 20mA).

EVALUATION MODE	BEST HIT
-----------------	----------

EVALUATION MODE:

This function field serves for setting the evaluation mode at the SPECTRO-3-ANA color sensor.

In evaluation modes **FIRST HIT, BEST HIT, MIN DIST and COL2** the function field **CALCULATION MODE** is active. Color information is calculated from the red, green, and blue raw data and is correspondingly evaluated.

In the **THD Red Green, THD Red Blue and Green Blue** evaluation modes only switching thresholds are defined for the respective channels. For evaluation the red, green, and blue raw data are considered individually. When the current signal is higher than the set switching threshold, the corresponding output is HI. When the signal is lower, the output changes to LO.

The **TEACH TABLE** is correspondingly adapted depending on **EVALUATION MODE** and **CALCULATION MODE**.

In the text below the **CALCULATION MODE "X Y INT - 2D"** is used to explain the evaluation modes **FIRST HIT, BEST HIT, MIN DIST and COL2**.

EVALUATION MODE FIRST HIT

	X	Y	CTO	INT	ITO	DP	
0	1937	1274	200	2208	200	0	
1	1468	1689	200	1860	200	0	
2	968	1049	200	2138	200	0	

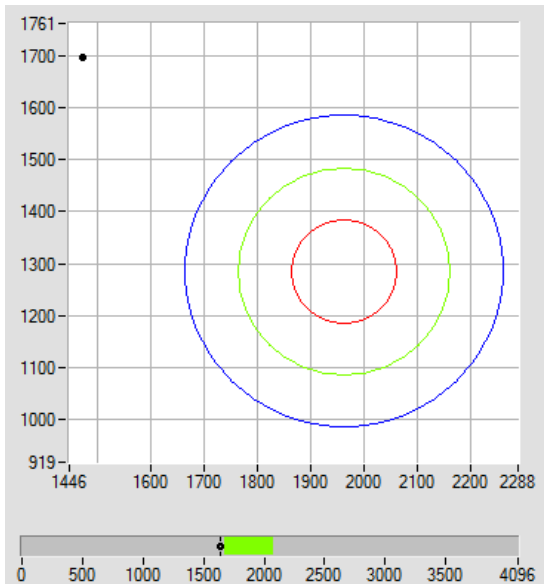

FIRST HIT:

The currently measured color values are compared with the default values in the **TEACH TABLE**, starting with teach-color 0. If in the row-by-row comparison the current color values correspond with the teach-parameters entered in the TEACH TABLE, this first "hit" in the TEACH TABLE is displayed as a color number (**C-No.**) and is output at the digital outputs (OUT0 and OUT1) according to the settings of the **OUTMODE** parameter (see **OUTMODE**).

If the current color does not correspond with any of the teach-colors, the color code **C-No.** = 255 will be set ("error status").

Tip! This mode is used if only one color is taught, and this color must be checked to avoid "drifting away". With the rising tolerance windows this can be detected very well, and countermeasures can be initiated, if necessary.

Tip! If, for example, only the X/Y coordinates should be checked, and intensity INT is of no importance, a tolerance of 4000 can be selected for **ITO**. This inspection criterion is thus always fulfilled.

Tip! Values can be entered in a cell of the table either by double-clicking on the respective cell, or by highlighting the respective cell and then pressing F2 .

Tip! The teach colors are only activated when the **SEND** button is pressed!

EVALUATION MODE BEST HIT

	X	Y	CTO	INT	ITO	DP	
0	1937	1274	200	2208	200	0	
1	1468	1689	200	1860	200	0	
2	968	1049	200	2138	200	0	

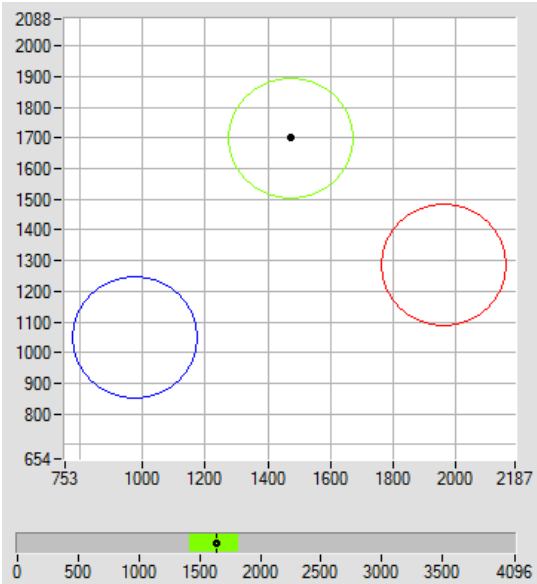

BEST HIT:

The currently measured color values are compared with the default values in the **TEACH TABLE**, starting with teach-color 0. If in the row-by-row comparison the current color values correspond with several of the teach parameters entered in the color table, the teach parameter that has the shortest x/y distance from the current color value will be a hit.

This "hit" in the TEACH TABLE is displayed as a color number (**C-No.**) and is output at the digital outputs (OUT0 and OUT1) according to the settings of the **OUTMODE** parameter (see **OUTMODE**).

If the current color does not correspond with any of the teach-in colors, the color code **C-No. = 255** will be set ("error status").

Tip! This mode is used if several colors must be separated from each other, and only certain surface fluctuations are allowed.

Tip! Since what you are looking for here with several "hits" is the shortest distance of the current color to the centres of the taught colors, the individual tolerance windows (circles) may overlap here. The sensor detects the "best hit".

Tip! Values can be entered in a cell of the table either by double-clicking on the respective cell, or by highlighting the respective cell and then pressing F2.

Tip! In **CALCULATION MODE = "X Y INT - 3D"** or **"s i M - 3D"** the shortest distance in a three-dimensional space is calculated.

Tip! The teach colors are only activated when the **SEND** button is pressed!

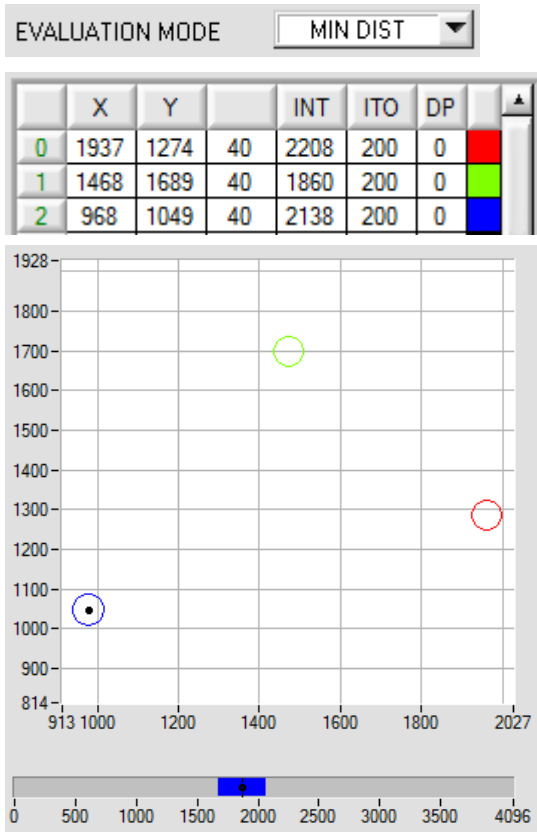

MIN DIST:

The individual teach-in colors defined in the TEACH TABLE are present as points in the color triangle, defined by their (X,Y) value pairs. When this evaluation mode is set at the sensor, the evaluation algorithm, starting from the currently measured color value (X,Y), calculates the distance to the individual teach-in colors in the color triangle. The current color value (X,Y) is assigned to the teach-in color that is closest in the color triangle.

It is furthermore checked whether the intensity condition for this color also is true. If the intensity condition is not true, the second shortest distance will be checked, etc.

The color detected this way is output at the digital outputs (OUT0 and OUT1) according to the settings of the OUTMODE parameter (see OUTMODE).

C-No. will only be set to 255, if the current intensity falls below the value set under INTLIM (see INTLIM).

Comment! The value of 40 is only entered here in order to be able to represent the coordinates of the individual teach colours in the graph. It has no meaning for evaluation.

Tip! This mode is used if you have taught several surfaces of separate colors, and a current color in any case must be assigned to one of the taught colors. This applies, for example, if you want to compensate a product variation, or if you have to solve sorting tasks.

Tip! If, for example, only the X/Y coordinates should be checked, and intensity INT is of no importance, a tolerance of 4000 can be selected for ITO. This inspection criterion is thus always fulfilled.

Tip! Values can be entered in a cell of the table either by double-clicking on the respective cell, or by highlighting the respective cell and then pressing F2.

Tip! In CALCULATION MODE = "X Y INT - 3D" or "s i M - 3D" the shortest distance in a three-dimensional space is calculated.

Tip! The teach colors are only activated when the SEND button is pressed!

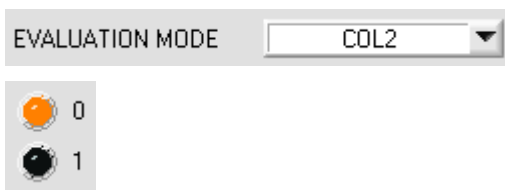

COL2:

In this evaluation mode the rows 0 and 1 in the TEACH TABLE are evaluated.

Every match of current vector (row number) and teach vector is directly sent to the corresponding output.

Example.

If the result of evaluation is that both row 0 as well as row 1 is a hit, outputs OUT0 and OUT1 will be set to high (+24V).

Tip! Values can be entered in a cell of the table either by double-clicking on the respective cell, or by highlighting the respective cell and then pressing F2.

Tip! The teach vectors are only activated when the SEND button is pressed!

Attention! In COL2 evaluation mode it is not possible to form color groups!

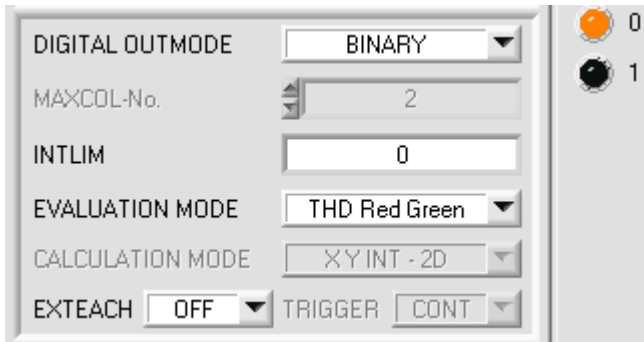

THD Red Green
 THD Red Blue
 THD Green Blue

The sensor has two digital outputs. These two outputs are directly activated when the respective channel drops below or rises above a certain threshold (THD=Threshold).

	THD					
0	2000	1	1	1	1	Red
1	3000	1	1	1	1	Green

Example:

EVALUATION MODE = THD Red Green

In the Teach Table a switching threshold of 2000 was set for **Red**, and a threshold of 3000 for **Green**.

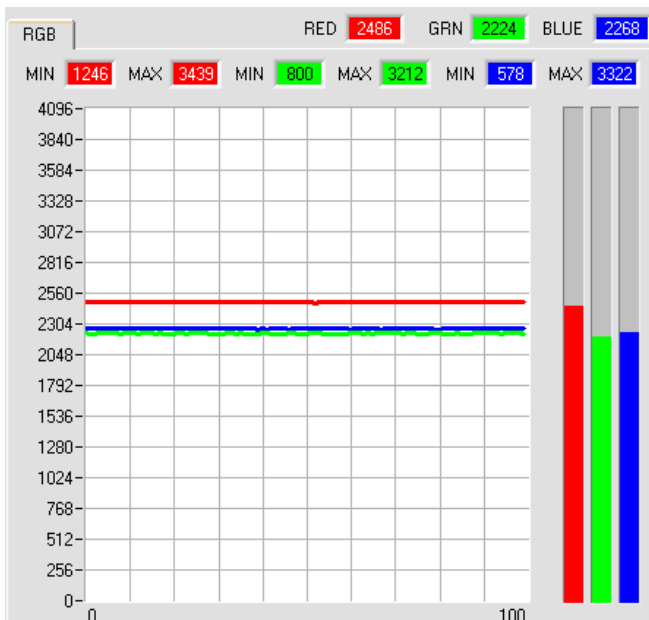

When the red channel becomes higher than 2000, output OUT0 switches to HI.

When it is lower than 2000, the output switches to LO.

In the example the green channel is lower than its switching threshold (3000). The output therefore is LO.

On the user interface this is visualised by the two LEDs 0 and 1.

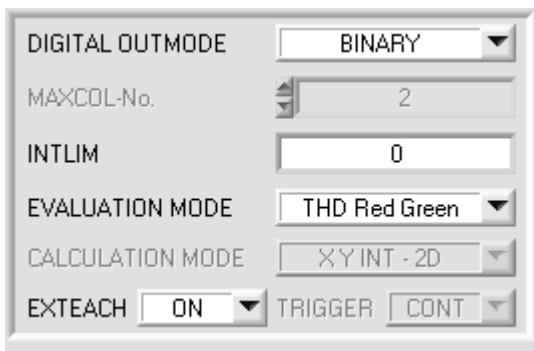

If **EXTEACH=ON** is selected in one of the three **THD** modes, the respective switching thresholds can be learned externally through input IN0.

As long as input IN0 is HI, a maximum and minimum value is determined in the sensor for the red, green, and blue channel.

When IN0 drops the switching threshold for the respective channels is calculated as follows:

$$THD=(MAX+MIN)/2$$

The determined **MIN-MAX** values for the **R G B** channels are displayed under the **RGB** tab.

Since the three **THD** modes are no color evaluation in the proper sense, certain input elements and display elements are hidden (**C-No.:**, **delta C**, ...) or greyed out (**TRIGGER**, **CALCULATION MODE**, **MAXCOL-No.**, ...).

CALCULATION MODE XY INT - 2D

CALCULATION MODE:

"X Y INT - 2D":

The X/Y pairs of the individual red, green, and blue components, and the intensity are used for evaluation. For X/Y a color tolerance **CTO** can be set, and for the intensity an **INT** tolerance **ITO** can be set. With the individual tolerances the color is represented as a cylinder in space (see picture below). **CTO** defines the diameter of the cylinder, and **ITO** the height of the cylinder.

"s i M - 2D":

The s/i pairs of the individual red, green, and blue components, and M are calculated for evaluation. This calculation method follows the Lab calculation method. For s/i a color tolerance **siTO** can be set, and for the intensity an **M** tolerance **MTO** can be set. With the individual tolerances the color is represented as a cylinder in space (see picture below). **siTO** defines the diameter of the cylinder, and **MTO** the height of the cylinder.

"X Y INT - 3D":

For evaluation, **X**, **Y**, and **INT** are calculated from the individual red, green, and blue components. These three values define a point in three-dimensional space. The tolerance value that is entered defines a sphere in space with radius **TOL** (see picture below).

"s i M - 3D":

For evaluation, **s**, **i**, and **M** are calculated from the individual red, green, and blue components following the Lab calculation method. These three values define a point in three-dimensional space. The tolerance value that is entered defines a sphere in space with radius **TOL** (see picture below).

Calculation of coordinates:

X s	X-value of the teach color (in the color triangle the numerical value of the x-axis: RED color component) $X = \frac{R}{R + G + B} * 4095$	s is calculated according to the L*a*b* color evaluation method. $s = 5000 * \left(\left(\frac{R}{4096} \right)^{1/3} - \left(\frac{G}{4096} \right)^{1/3} \right) + 5000$
--------	---	--

Y i	Y-value of the teach color (in the color triangle the numerical value of the y-axis: GREEN color component) $Y = \frac{G}{R + G + B} * 4095$	i is calculated according to the L*a*b* color evaluation method. $i = 2000 * \left(\left(\frac{G}{4096} \right)^{1/3} - \left(\frac{B}{4096} \right)^{1/3} \right) + 2000$
--------	---	--

INT M	Intensity value of the respective color. $INT = \frac{R + G + B}{3}$	M is calculated according to the L*a*b* color evaluation method. $M = 1160 * \left(\frac{G}{4096} \right)^{1/3}$
----------	---	--

CTO siTO	In CALCULATION MODE "X Y INT - 2D" or "s i M - 2D" , CTO or siTO is the color tolerance radius around the respective taught X/Y or s/i pair. CTO or siTO defines the radius of the color cylinder in space. In this thus-defined "tolerance circle" the current color is recognised as the teach color. A color is recognised if delta C is smaller than CTO or siTO and INT or M lies in the intensity window that is defined by INT±ITO or M±MTO . Moreover, the current double parameter set (DP SET) must match the learned value DP.	
-------------	---	--

ITO MTO	In CALCULATION MODE "X Y INT - 2D" or "s i M - 2D" , ITO or MTO is the intensity tolerance window around the respective taught intensity INT or M . ITO or MTO defines the height of the color cylinder in space. In this thus-defined "tolerance window" the current color is recognised as the teach color. A color is recognised if delta C is smaller than CTO or siTO and INT or M lies in the intensity window that is defined by INT±ITO or M±MTO . Moreover, the current double parameter set (DP SET) must match the learned value DP.	
------------	---	--

TOL	In CALCULATION MODE "X Y INT - 3D" or "s i M - 3D" , TOL is the tolerance radius around the respective taught point "X Y INT - 3D" or "s i M - 3D" in space. TOL defines the radius of the color sphere in space. In this sphere the current color is recognised as the teach color. A color is recognised if delta C is smaller than TOL . Moreover, the current double parameter set (DP SET) must match the learned value DP.	
-----	---	--

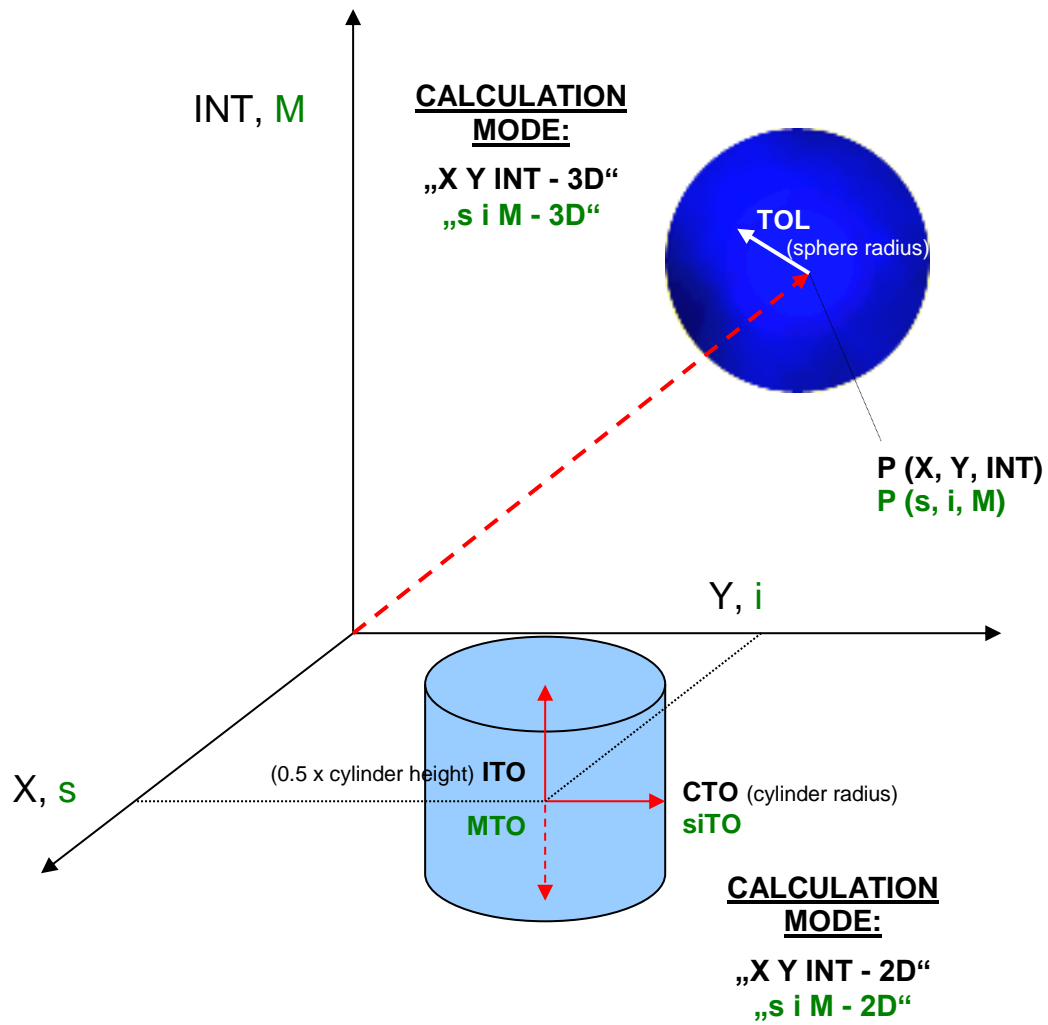

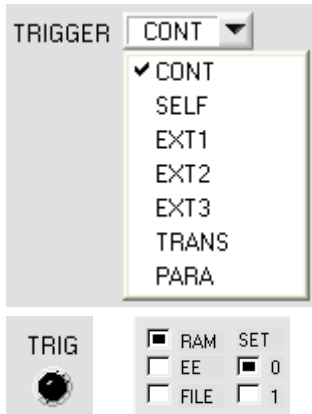

TRIGGER:

This function field serves for setting the trigger mode at the sensor. If **TRIGGER** is not **CONT**, the **TRIG** LED shows a trigger event.

CONT: Continuous color detection (no trigger event required).

SELF: By selecting **SELF** the sensor can be operated in self-trigger mode. The "free status" must be taught to row 0. With a split optical fibre in transmitted-light operation the free status, for example, is the uncovered status. In reflected-light operation the free status is the status when there is no part. Color detection is started when row 0 is no longer detected (self-trigger). After the trigger, i.e. when color 0 is detected again, the color from the taught colors will be output that was detected most frequently during triggering. When the sensor leaves row 0, row 0 will be output in accordance with the output mode. When it returns to row 0, an error will be output, or the color that was present for the longest time.

This means that after a self-trigger there always is a change of output states.

The same applies to **COLOR GROUP = ON**. When the sensor leaves group 0, group 0 will be output in accordance with the output mode. When it returns to group 0, an error will be output, or the group that was present for the longest time. This means that even if an individual color was present for the longest time it will not be output if, for example, two colors that belong to the same group together were present for a longer time. Furthermore, several colors can be combined in group 0 for the trigger condition, because the leaving of group 0 determines the trigger condition.

After dropping of the trigger an average over **X, Y, INT (or siM)** and **delta C** is output once. The average is determined from all the color hits, but not from row 0, and can be acquired with **RECORD MODE = AUTO TRIGGERED**.

EXT1: Color detection is started through the external trigger input (IN0 Pin3 grn at cable cab-las8/SPS). After triggering the color from the taught colors or groups in case of **COLOR GROUP = ON** will be output that was detected most frequently during triggering. Furthermore, an average over **X, Y, INT (or siM)** and **delta C** is output once. The average is determined from all the color hits and can be acquired with **RECORD MODE = AUTO TRIGGERED**.

EXT2: Color detection is started through the external trigger input (IN0 pin3 green of cable cab-las8/SPS). A trigger event is recognized as long as +24V is present at the IN0 input (HIGH-active). After the trigger input goes to LOW again, the state (C-No.) that was last detected will be held at the outputs.

EXT3: Same behaviour as in EXT2 mode, with the difference that an error state (color no. = 255) will be output after the trigger input goes to LOW again.

TRANS:

Same behaviour as in **CONT**. However, in contrast to **CONT** in this mode the transmitter source will be switched off if no trigger event (IN0) is given.

PARA:

If you work with **TRIGGER=PARA**, two parameter sets can be saved for the sensor.

SET can then be used to select whether the current parameters on the user interface should be saved as parameter set 0 or parameter set 1 in the sensor.

The external trigger input (IN0 pin3 grn of the cable cab-las8/SPS) is used to tell the sensor which parameter set it should work with.



On the software interface the status of IN0 is displayed by the **TRIG** LED. If this LED is black, IN0=LO=0V, and the sensor operates with parameter set 0.

If this LED is green, IN0=HI=+24V, and the sensor operates with parameter set 1.

To watch the signal on the software interface, select 0 or 1 depending on **TRIG SET**, and then click on the **GET** button.

SET only is active with **TRIGGER=PARA**.

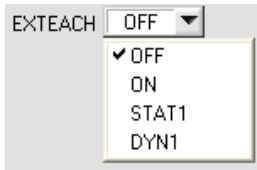

EXTEACH:

In all the evaluation modes teaching of a color can be performed externally through IN0.

- OFF:** The external TEACH feature is deactivated.
- ON:** See below

STAT1: In static power mode, a color is taught to position 0 in the **TEACH TABLE**. The **POWER MODE** is automatically set to **STATIC**. A fixed transmitter poser must be set with the **POWER** slider. After a positive signal (+24V) at input IN0, the current color is taught to row 0. The taught color is stored only in the **RAM** and not in the **EEPROM** of the sensor.

DYN1: In dynamic power mode, a color is taught to position 0 in the **TEACH TABLE**, and evaluation is then performed statically. The **POWER MODE** is automatically set to **STATIC**. After a positive signal (+24V) at input IN0, the transmitter power is set such that the sensor is in the dynamic range, which is defined by **DYN WIN LO** and **DYN WIN HI**. The current color is then taught to position 0 in the **TEACH TABLE**. The sensor then continues to operate statically with the established **POWER** value. The taught color is stored only in the **RAM** and not in the **EEPROM** of the sensor.

ATTENTION! If **EVALUATION MODE = FIRST HIT**, the rows up to **MAXCOL-No.** are filled with the same teach values with **EXTEACH = ON, STAT1** and **DYN1**.

TEACH PROCESS WITH EXTEACH=ON:

Through IN0, the sensor can be taught up to 31 colors.

In evaluation mode **FIRST HIT** the currently present color is taught to all active rows depending on **MAXCOL-No.**

In the evaluation modes **BEST HIT, MIN DIST,** and **COL2** a single row in the **TEACH TABLE** can be selected through IN0.

The example shows the external teaching of 4 colors in **EVALUATION MODE = BEST HIT**.

Select the **EXTERN TEACH = ON** function.

Adjust the power value such that the sensor is neither overloaded nor that a too low signal arrives at the sensor.

Select how many colors you wish to teach from extern.

Click on the **TEACH TABLE** tab to switch to the **TEACH TABLE**.

Then enter the corresponding tolerances for the colors you want to teach.

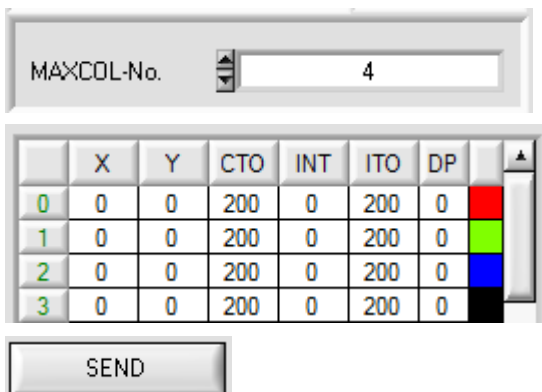

In this example, **MAXCOL-No. = 4** was selected, i.e. the sensor should detect the color information that is stored in the first 4 rows of the **TEACH TABLE** by means of external teaching through IN0. Since the sensor cannot calculate the tolerances for color circle (**CTO**) and intensity (**ITO**) itself, these values must be entered once only (in this case 200 at all places) and must be stored in the **EEPROM** together with the **MAXCOL-No.** and with **EXTEACH = ON**.

Now select the setting **EEPROM** in the function field, and then click on **SEND**.

From now on, the PC is no longer necessary, as long as you only wish to teach colors up to the **MAXCOL-No.** and do not want to change the tolerances.

Comment: **MAXCOL-No = 4** can be selected if **COLOR GROUPS = ON** is used.

INFO:

Of course the taught colours can be viewed at any time with the PC.

Colors that are taught by way of **EXTEACH = ON** are stored in the **EEPROM** of the sensor, i.e. the information will not be lost when the system is turned off.

This function rather is intended for "after-teaching", because the sensor does not automatically adjust its **POWER** value.

EXTEACH=ON:

Before the external teach-process can be started, the color to be taught must be presented to the sensor. The external teach process is started with a positive edge at IN0 (green wire). The outputs OUT0 and OUT1 alternately change their state between 0V and 24V. From now on, the user has a certain number of seconds time to inform the sensor about the position at which the color information (**X Y INT** or **siM**) should be placed in the **TEACH TABLE**. The **BUSY** window is the time that the user has for informing the sensor about the teach rows. It depends on the value that is set in **MAXCOL-No.** (e.g. approx. 5 seconds when **MAXCOL-No.** = 5).

The first positive edge (start edge 0) selects position 0 in the **TEACH TABLE**. Every additional positive edge selects one position higher (see table below).

Example:

If you wish to save the current color to position 3 in the **TEACH TABLE**, the following steps have to be performed:

1. Start the external TEACH process with a positive edge (0) at IN0 → Position 0 is selected.
2. Another positive edge (1) selects position 1 in the TEACH TABLE.
3. Another positive edge (2) selects position 2 in the TEACH TABLE.
4. Another positive edge (3) selects position 3 in the TEACH TABLE.
5. The desired position is now selected.
6. When the **BUSY** window is over, the sensor starts the evaluation.
7. To teach another color → go to pos. 1

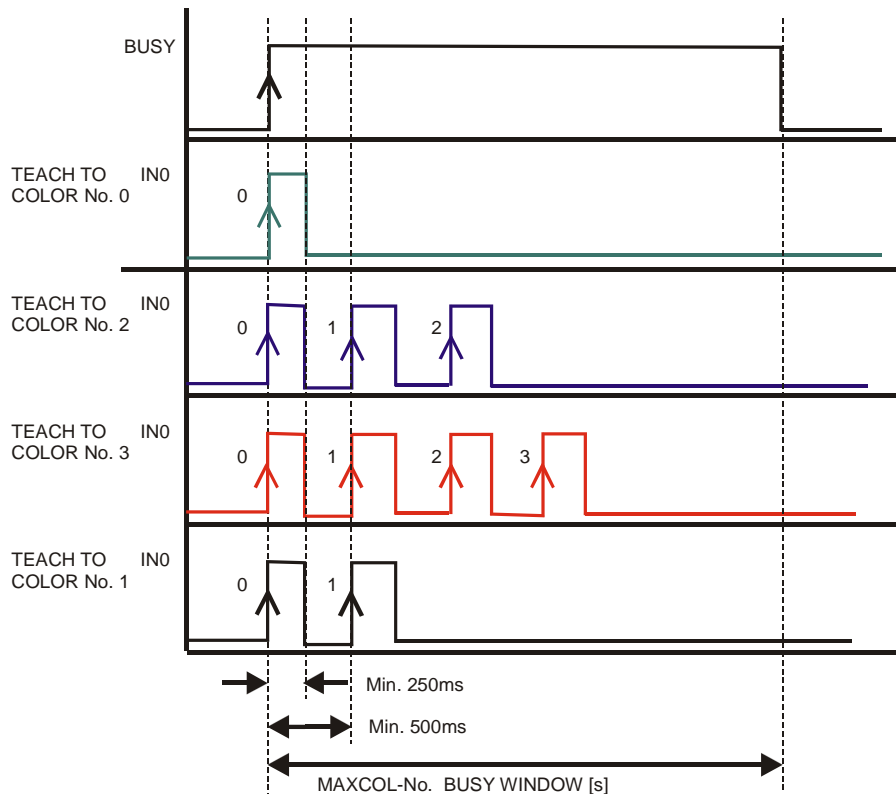

INTLIM

INTLIM:

This edit box is used for setting an intensity limit. Color evaluation is stopped, if the current intensity **INT** arriving at the receiver unit falls below this limit, and **ERROR STATE** is output.

With **POWER MODE = DYNAMIC** the **POWER** value is used for intensity evaluation, and no longer the intensity that is calculated from the signals (see above). The **INT** or **M** display therefore does not show the "true" intensity, but the transmitter intensity that corresponds with the actual **POWER** parameter.

In the sensor, however, the "true" intensity is still calculated and used for the interrogation of **INTLIM**.

Attention: ERROR STATE if: INT < INTLIM

MAXCOL-No.

MAXCOL-No.:

This function field is used to set the number of colors that should be checked.

With **OUTMODE = BINARY HI** or **BINARY LO** a maximum of 3 colors or color groups can be taught.

With **OUTMODE = DIRECT HI** or **DIRECT LO** a maximum of 2 colors or color groups can be taught.

If **COLOR GROUPS = ON**, the sensor can be taught up to 64 colors.

However, only 3 groups can be formed with **OUTMODE = BINARY** and 2 groups with **DIRECT HI** or **LO**.

In the **TEACH TABLE** rows 3-63 therefore have gray background.

The numerical value that is set here determines the current possible scan rate of the color sensor. If the number of colors to be checked is lower, the sensor operates faster. The numerical value that is defined here refers to the number of rows (starting with row 0) in the **TEACH TABLE** (→ 2.4 TEACH TABLE tab).

DIGITAL OUTMODE

DIGITAL OUTMODE:

This function field is used to determine the operating mode of the digital outputs.

DIRECT HI:

In this mode a maximum of 2 teach colors or 2 color groups is permitted.

If in the row-by-row comparison the current color values correspond with the teach parameters entered in the color table, the respective digital output (OUT0 and OUT1) is switched to HIGH.

If no color is detected the digital outputs are in LOW state.

DIRECT LO:

In this mode a maximum of 2 teach colors or 2 color groups is permitted.

If in the row-by-row comparison the current color values correspond with the teach parameters entered in the color table, the respective digital output (OUT0 and OUT1) is switched to LOW.

If no color is detected the digital outputs are in HIGH state.

BINARY HI:

In this mode a maximum of 3 teach colors or 3 color groups is permitted.

If in the row-by-row comparison the current color values correspond with the teach parameters entered in the color table, this "hit" in the color table is provided as a **bit pattern** at the digital outputs (OUT0 and OUT1).

BINARY LO:

Same function as **BINARY HI**, but the **bit pattern** is output inversely.

2.3 Tab PARA2

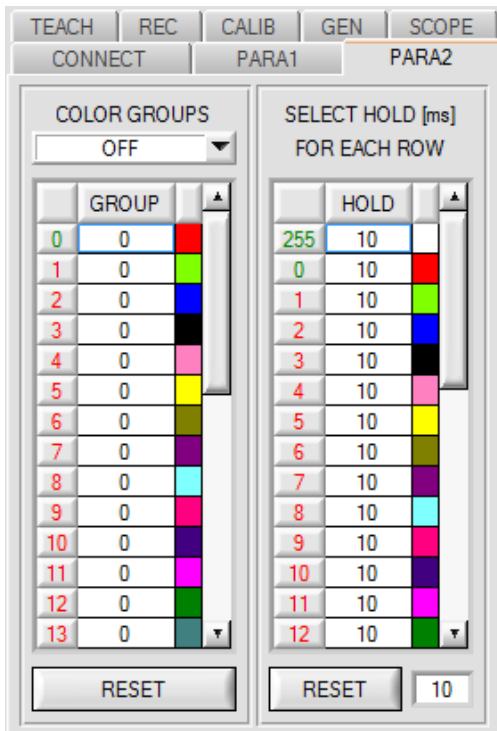

PARA2:

A click on **PARA2** opens a view where colors in the **TEACH TABLE** can be assigned to certain groups, and for each color and the error status an explicit **HOLD** time can be set.

Please note:

The sensor must be informed about the color groups and HOLD settings by pressing SEND.

COLOR GROUPS:

It is possible to form color groups in evaluation modes **FIRST HIT**, **BEST HIT**, and **MIN DIST**. This means that in a special table the individual rows are assigned to a group.

In this example, **COLOR GROUPS** has been set to **ON**, i.e. group evaluation is activated.

Rows 0 and 1 have been assigned to group 0.

Rows 2 and 3 have been assigned to group 1, and row 4 to group 2.

A **GRP** display is shown under the **C-No:** display.

If, as in this example, row 3 is detected in the evaluation, this row and the corresponding group will be visualised.

The group number will be output through outputs OUT0 and OUT1.

A total number of 64 different colors can be taught.

In evaluation mode **DIRECT HI** and **DIRECT LO** a maximum of 2 groups can be formed (group 0 and 1).

In evaluation mode **BINARY HI** and **BINARY LO** 31 groups can be formed.

All the cell values can be set to 0 by pressing **RESET**.

A double-click on the **GRP** display opens a larger display window.

HOLD in milliseconds [ms]:

The sensor operates with minimum scanning times in the magnitude of less than 100µs. This is why most of the PLCs that are connected to the digital outputs have difficulties with the safe detection of the resulting short switching state changes. Entering values in the table provides pulse lengthening at the digital outputs of the sensor system up to 100 ms. Each individual row can be assigned its own HOLD time.

When the **RESET** button is pressed, the complete table is set to the reset value indicated beside the **RESET** button.

Example:

Print marks are transported at a very high speed. The print marks are positioned in the sensor's range only for a very short time (milliseconds or even shorter). A minimum pulse of 10 ms is required for the reliable detection of a mark.

The background is taught to row 0, and the print mark to row 1. This is desirable because it allows the use of the **BEST HIT** evaluation mode.

If row 0 and row 1 overlap seamlessly, the sensor operates perfectly. The output is immediately activated and remains active at least for the time specified in the corresponding row.

If row 0 and row 1 do not overlap, the sensor detects an error at the transition from row 0 to row 1 (print mark), which immediately is sent to the output and remains active there at least for the **HOLD** time. An error inevitably would occur here if **HOLD** for the error state (255) was chosen too high, because the sensor only outputs a status change again after **HOLD** has elapsed (this may be the print mark, but it does not have to be).

It is absolutely necessary here to select a **HOLD** time of 0 for error state 255.

2.4 Tab TEACH

When the **GO** button is pressed, data transfer from the sensor to the PC is started. The respective RED, GREEN, and BLUE contents are shown by way of the bars beside the graph. The calculated **X, Y, INT** or **s,i,M** values are visualised in the displays.

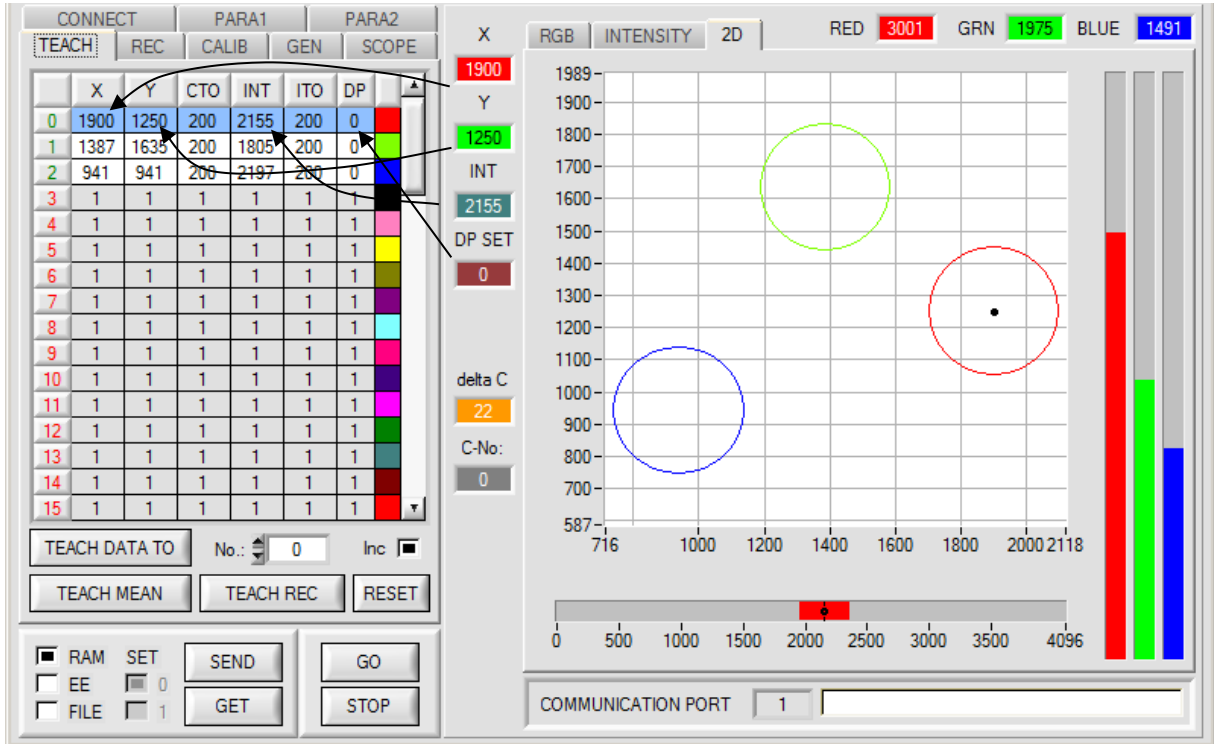

X or s:

This numerical value output field displays the RED content (x-axis) of the scattered light currently arriving at the receiver.

Y or i:

This numerical value output field displays the GREEN content (y-axis) of the scattered light currently arriving at the receiver.

INT or M:

This numerical value output field displays the currently measured intensity (proportional to the average of the intensities at the triple receiver).

DP SET:

This output field displays with which **DOUBLE PARAMETER SET** the sensor is currently working. In **POWER MODE = STATIC** and **DYNAMIC** this value is always 0, i.e. the sensor operates with the values for **POWER, INTEGRAL** and **GAIN** which were set in the **PARA1** tab. In **POWER MODE = DOUBLE** the sensor switches back and forth between two sets (1 and 2) (see **SET DP**).

C-No.:

This numerical value output field displays the currently detected color number in accordance with the entry in the **TEACH TABLE**. The currently detected color number is sent to the digital outputs OUT0 and OUT1 as a corresponding bit pattern.

The value 255 means that none of the taught colors is recognised.

A double-click on the display opens a larger display window.

Please note: The above-mentioned output fields are only updated when data transfer between PC and sensor is active (**GO** button pressed).

	X	Y	CTO	INT	ITO	DP	
0	1900	1250	200	2155	200	0	Red
1	1387	1635	200	1805	200	0	Green
2	941	941	200	2197	200	0	Blue
3	1	1	1	1	1	1	Black
4	1	1	1	1	1	1	Pink
5	1	1	1	1	1	1	Yellow
6	1	1	1	1	1	1	Olive
7	1	1	1	1	1	1	Purple
8	1	1	1	1	1	1	Cyan
9	1	1	1	1	1	1	Magenta
10	1	1	1	1	1	1	Dark Purple
11	1	1	1	1	1	1	Bright Magenta
12	1	1	1	1	1	1	Green
13	1	1	1	1	1	1	Teal
14	1	1	1	1	1	1	Dark Red
15	1	1	1	1	1	1	Red

TEACH DATA TO No.: 0 Inc

TEACH MEAN TEACH REC RESET

TEACH:

A click on the **TEACH** tab opens a view where colors can be taught to the **TEACH TABLE**.

Please note: The sensor must be informed about the teach colors by pressing SEND.

After a left mouse button double click (or a click on shortcut key button F2) on the respective field the default values can be changed by entering numerical values with the PC keyboard.

The **TEACH TABLE** is organized in rows, i.e. the individual parameters for the teach-in colors are arranged side by side in the respective row.

The sensor is able to check up to 64 teach-in colors. The number of the respective teach-in color is given in the left column of the table.

Only the green rows are used for evaluation in the sensor. The number of rows to be inspected is set with **MAXCOL-No.**

When **TEACH DATA TO** is pressed, the currently displayed data for **X, Y, INT, DP SET** or **s, i, M, DP SET** are transferred to the row in the **TEACH TABLE** that is selected under **No.:**

A Color Tolerance (**CTO**) and an Intensity Tolerance (**ITO**) also are set. If necessary, these tolerances, as well as the teach values, can be changed as described above.

No.: also is used to select which **INT** or **M** tolerance window is shown in the respective graphs for the intensity or for M.

When **Inc:** is activated, and the **TEACH DATA TO** button is pressed, the **No.:** input field is automatically incremented (increased) by 1, i.e. the next row in the **TEACH TABLE** is selected

A click on the **RESET TABLE** button resets the **TEACH TABLE** (RESET value = 0)

	X	Y	INT	TOL		DP	
0	1956	1307	919	200	1	0	Red
1	1473	1686	742	200	1	0	Green
2	969	1055	875	200	1	0	Blue
3	0	Help					Black
4	0	Set selection to					Pink
5	0	Increment selection with					Yellow
6	0	Reset selection					Olive
7	0	Teach tolerance off					Purple
8	0	Teach tolerance on					Cyan
9	0						Magenta

VALUE!

Insert a cell value!

OK

With **Set selection** to several cells in the **TEACH TABLE** can be filled with a value.

For this purpose the cells that should be changed must first be selected.

A right mouse click then opens a popup menu.

If you click on **Set selection to** there, a popup window will open where you can enter the value to which the cells should be changed.

	X	Y	INT	TOL		DP	
0	1956	1307	919	200	1	0	Red
1	1473	1686	742	250	1	0	Green
2	969	1055	875	300	1	0	Blue

Help

Set selection to

Increment selection with

Reset selection

Teach tolerance off

Teach tolerance on

Incrementing tolerance values can be entered by using **Increment selection with.**

The start value is the value of the topmost left cell.

Starting from this cell the following cells are increased each by the value that is entered in the popup window.

A click on **Reset selection** resets the selected cells to a value of 1.

When you use **TEACH DATA TO** the software suggests tolerance values and writes these values to the respective cells.

This function can be turned off and on with **Teach tolerance off** and **Teach tolerance on.**

A click on **Help** opens a popup window that provides explanations for the respective functions.

The following panel will be displayed after a click on **TEACH MEAN VAL.**

The Teach Panel can be used in every **EVALUATION** and **CALCULATION MODE**. The explanation herein uses the **EVALUATION MODE=BEST HIT** and the **CALCULATION MODE="X Y INT - 2D"**.

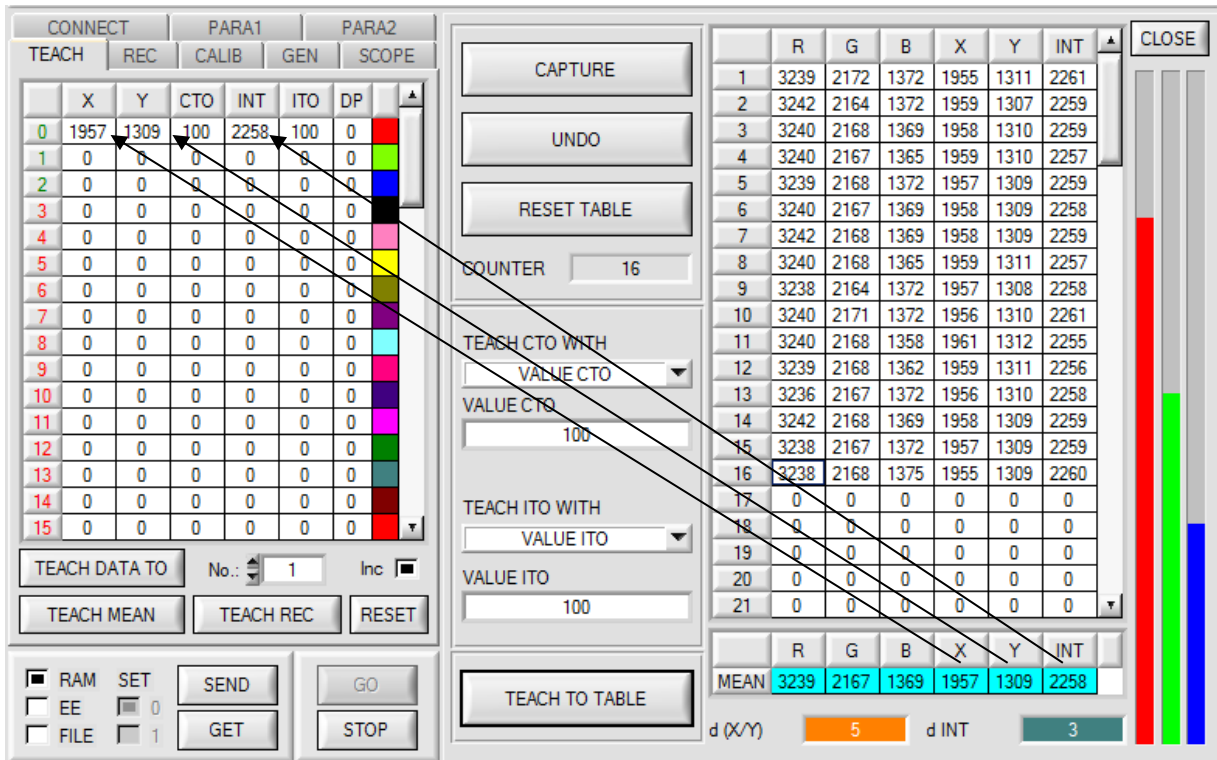

Data are automatically gathered from the sensor and displayed.

A click on the **CAPTURE** button enters a parameter frame in the table.

The **COUNTER** display field shown how many frames have already been recorded.

The last frames that were entered in the table can be deleted again by pressing **UNDO**.

RESET TABLE sets the whole table back to 0.

After every activation of **CAPTURE**, **UNDO**, or **RESET TABLE**, the mean values for the individual parameters are calculated automatically and are displayed in the mean value table.

Furthermore, a maximum color deviation **d(X/Y)** and a maximum intensity deviation **dINT** for the average values will be formed.

When the **TEACH TO TABLE** button is pressed, the respective mean values are taught to the row in the **TEACH TABLE** that is selected under **No.:** (→ 2.3 Tab TEACH TABLE).

Teaching of the circular tolerance and of the intensity tolerance can be set by way of **TEACH CTO WITH** and **TEACH ITO WITH**, respectively.

- If the setting is **VALUE CTO**, the value that is set under **VALUE CTO** will be taught (ditto intensity).
- If the setting is **d(X/Y)**, the value that is determined under **d(X/Y)** will be taught (ditto intensity).
- If the setting is **d(X/Y) + VALUE CTO**, the value that is determined under **d(X/Y)** plus **VALUE CTO** will be taught (ditto intensity).
- With **NO CHANGE**, the value that is set in the **TEACH TABLE** will remain unchanged.

A click on the **CLOSE** button will take you back to the main panel.

A click on the button **TEACH REC VAL** (teach recorded values) opens a panel on the right side which, after a click on the **START** button, starts to record data and display them in the three graphs. This function is useful if the material to be detected cannot be directly placed in front of the sensor, for example because it is transported on a conveyor belt that cannot be stopped or cannot be exactly stopped at the position required for teaching. After some time, area centres will become apparent that can be assumed to be the objects to be taught. The screenshot below shows 4 of these positions.

After a click on **STOP** the cursor can then be positioned on such an area centre in any of the graphs. The cursor will be automatically positioned in the other two graphs.

With **TEACH TO TABLE** the current cursor position can then be transferred to the **TEACH TABLE**. Teaching will be performed to the row that is set under **No.:**.

RESET can be used to reset the graphs and the counter.

CLOSE takes you back to the main panel.

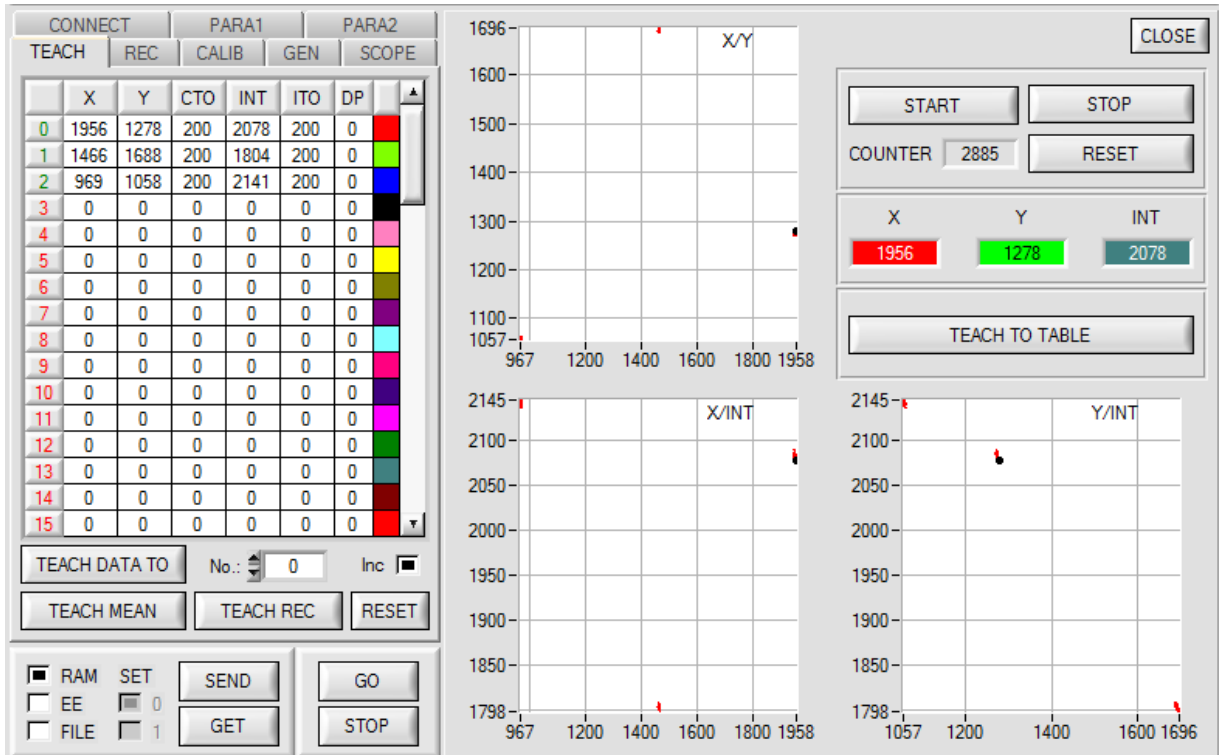

2.5 Tab GEN

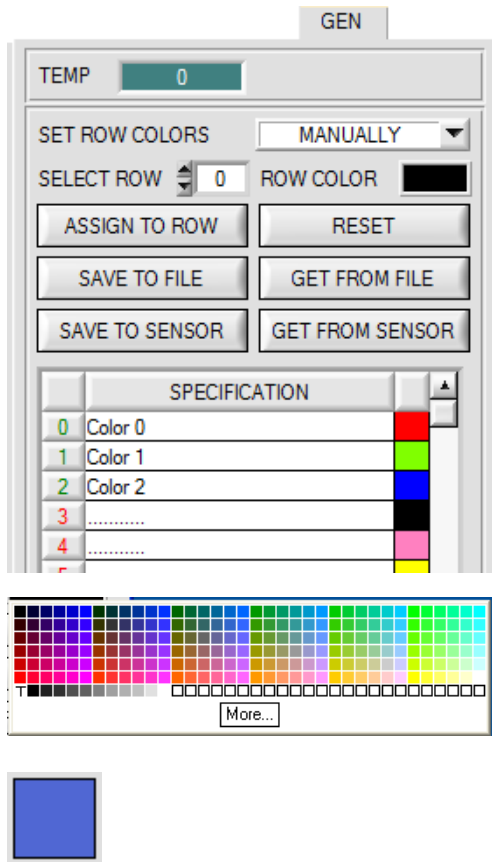

GEN:

A click on **GEN** opens a display of the current temperature value **TEMP** in the sensor housing. The display is **NOT** in degrees Celsius or Fahrenheit.

In the GEN tab you also can manually select the row colors in which the individual tolerance circles are displayed, or let the system set these colors automatically based on the colors detected by the system.

Furthermore, designations for the individual rows can be entered in the **SPECIFICATION** table. These designations are saved on the PC's hard disk and can be loaded again, if necessary.

If **SET ROW COLOR** is set to **MANUALLY**, the row color that should be changed must be set under **SELECT ROW**.

A click on the colored area of **SELECT COLOR** opens a color palette where the desired color can be selected. After a click on the **SET** button, the color will be displayed in the 6th column and the selected row of the **TEACH TABLE**.

If **SET ROW COLOR** is set to **AUTOMATICALLY**, the system will automatically calculate the corresponding row color, display the color in a color display beside the graph and, after a click on **TEACH DATA TO**, automatically insert it in the corresponding row.

The **SAVE TO FILE** and **GET FROM FILE** functions allow you to save specified row color arrays and the **SPECIFICATION** table on the hard disk, or to load previously saved arrays.

SAVE TO SENSOR and **GET FROM SENSOR** writes these to the sensor or reads them from the sensor, respectively.

A click on **RESET** resets the colors to a default value.

When the software is started again, the **ROW COLOR** table and the **SPECIFICATION** table that were active when the software was closed are automatically loaded again.

2.6 Tab REC

The SPECTRO3-ANA-Scope software features a data recorder that makes it possible to save the data that are acquired and calculated by the sensor. The recorded file is saved to the hard disk of the PC and can then be evaluated with a spreadsheet program.

The file that is created has 13 columns and as many rows as data frames were recorded. A row is structured as follows:

Date, time, RED, GREEN, BLUE, X, Y, INT, delta C, COLOR, GROUP, TRIGGER, TEMP

The following steps describe how data frames are recorded with the recorder:

Please note:

Recording depends on the **EVALUATION MODE** that is chosen. Several **EVALUATION MODES** do not need certain data, therefore these data will be set to 0, i.e. for these data the value 0 will be recorded.

Step 1:

When the **REC** button is pressed, the following window will be displayed:

When the **SHOW GRAPH** button is pressed, a panel will be displayed that allows the user to monitor the different signals.

The individual signals can be activated from the **SIGNAL** drop-down menu.

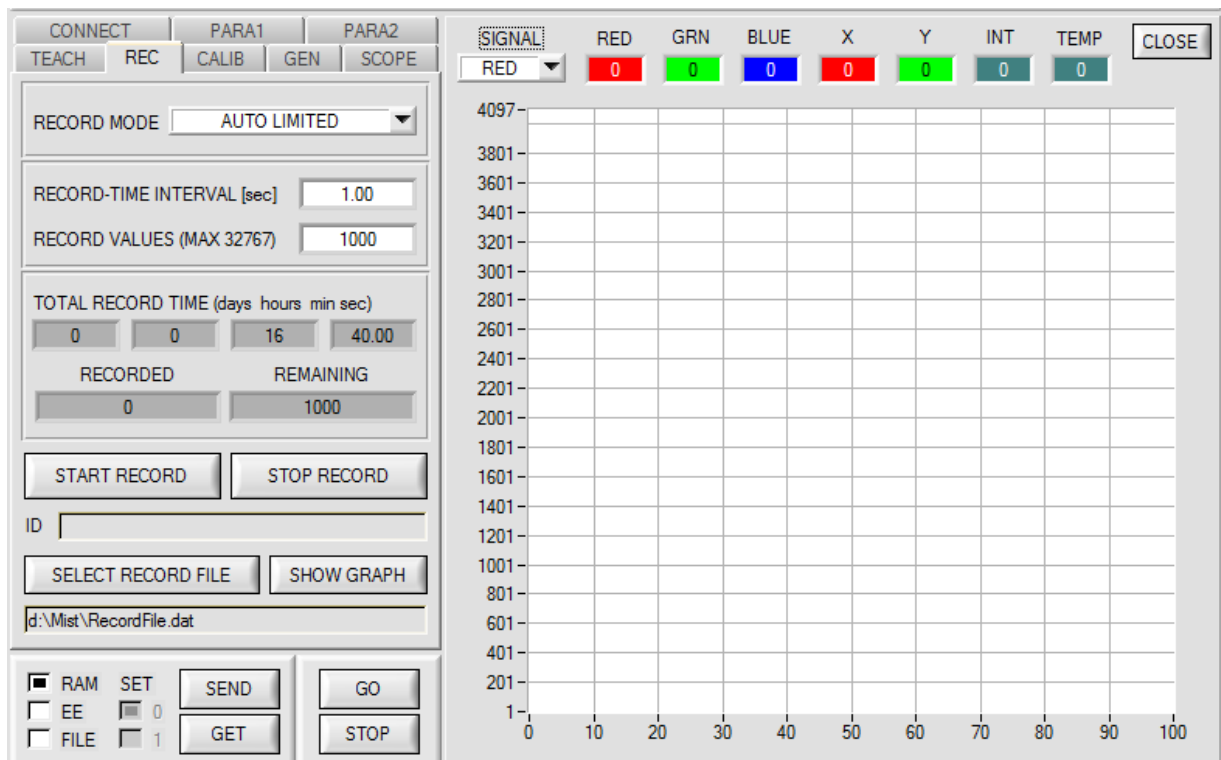

Step 2:

If you want to automatically record several data frames, please select **AUTO LIMITED** under **RECORD MORE**. Enter a time interval for recording under **RECORD-TIME INTERVAL [sec]**, in this example: 1, i.e. a new value is called from the sensor every second). Then enter the maximum number of values you wish to record in the **RECORD VALUES [MAX 32767]** field. Please note: Recording can also be stopped earlier by clicking **STOP RECORD**, the data recorded so far will not be lost.

The **TOTAL RECORD TIME** field indicates how long recording will take (in days, hours, minutes, and seconds) if all data are recorded.

Step 3:

By pressing the button **SELECT RECORD FILE** a file can be selected in which the data frame will be stored. If you select an already existing file name, you will be asked whether you want to overwrite the existing file or not.

Step 4:

Pressing the **START RECORD** button starts automatic data recording.

The recorder starts to record data, and the button **START RECORD** is red to indicate that recording is active. The respective data frames are shown in the display windows.

In the two display fields **RECORDED** and **REMAINING** you can check how many data frames have been recorded, and how many frames remain to be recorded.

Please note:

During recording the two input fields RECORD-TIME INTERVAL and VALUES TO BE RECORDED are inactive.

Step 5:

When as many data frames as set under **RECORD VALUES [MAX 32767]** have been recorded, or when the **STOP AUTO RECORD** button is pressed, a pop-up window will appear which confirms that the file is stored.

If you want to record an unlimited number of data, select the **AUTO UNLIMITED** function under **RECORD MORE**. Then select the desired recording interval and press **START RECORD**.

If you want to record data "manually", select the **MANUAL RECORDING** function under **RECORD MORE**. You can start reading data from the sensor by pressing the **GO** button. These data are visualised in the display window. Pressing the **CAPTURE DATA FRAME** button saves a data frame in the file that was selected under **SELECT RECORD FILE**. The **RECORDED** field shows the sum of the frames already recorded.

If **AUTO TRIGGERED** is selected under **RECORD MORE**, and **TRIGGER = SELF, EXT1, EXT2, EXT3, TRANS** or **PARA** is selected, the sensor will automatically send a data frame after each drop of the trigger when **START RECORD** is pressed. This data frame is captured and recorded by the recorder. Pressing the **STOP RECORD** button terminates the automatic sending function of the sensor again.

Please note:

When you press START RECORD, the file that is selected under SELECT RECORD FILE will be deleted. With RECORD FRAME MANUALLY, the file will be created if it does not already exist. If the file already exists, the data are added to the existing file.

2.7 Tab CALIB

2.7.1 White light balancing

White light balancing can be performed with the sensors of the SPECTRO-3-ANA series. Balancing can be performed to any white surface. A ColorChecker™ table with 24 color fields according to CIE standard is available as an alternative, and white light balancing or calibration can then be performed to one of the white fields

The following panel will be displayed after a click on **CALIB**:

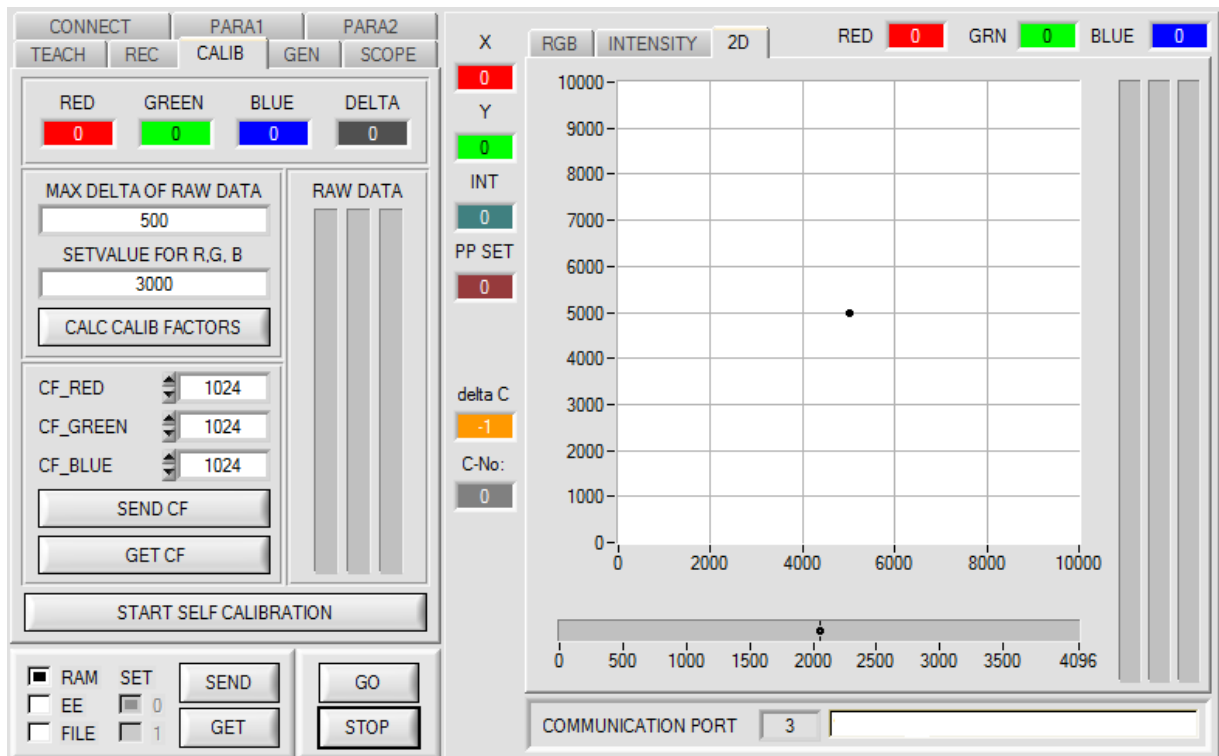

Calculation example for determining the calibration factors

In the example in the picture below, a POWER value at which the three bars of the raw signals **RAW DATA** are in the dynamic range has been set. Each of the three bars is at approx. 3000 digits. It is thus appropriate to set a setpoint value of 3000 (see **SETVALUE FOR R,G,B**) for the three bars. When calibration is now started by pressing CALCULATE CALIBRATION FACTORS, the software automatically calculates the calibration factors for channel RED, channel GREEN, and channel BLUE. The calibration factors are normalized as integers to the value 1024.

Formula:

$$CF_RED = (SETVALUE / RAW\ DATA\ RED) * 1024 = (3000 / 3007) * 1024 = 1021$$

$$CF_GREEN = (SETVALUE / RAW\ DATA\ GREEN) * 1024 = (3000 / 3097) * 1024 = 992$$

$$CF_BLUE = (SETVALUE / RAW\ DATA\ BLUE) * 1024 = (3000 / 2908) * 1024 = 1056$$

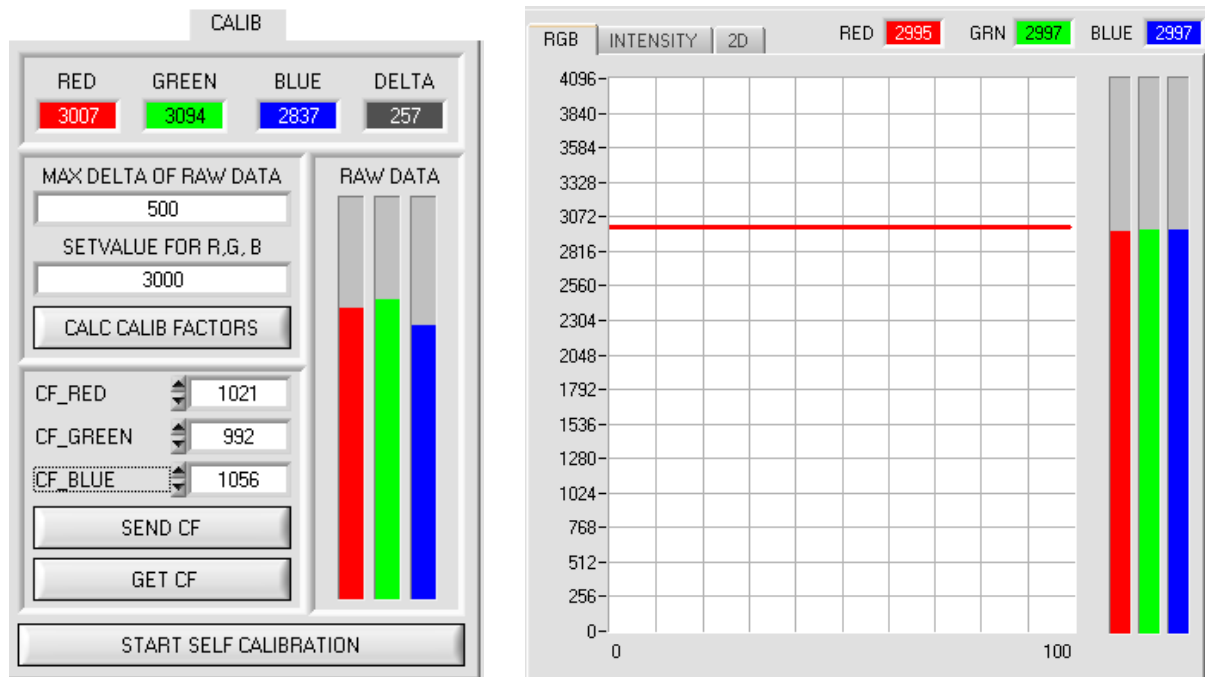

When the calibration factors have been calculated by the software on the user interface, they are automatically saved to the non-volatile **EEPROM** memory of the sensor. Calibration is then finished, work can then be continued in the main panel.

When the sensor detects a raw signal, it applies the calibration factor saved in the **EEPROM** to this raw signal, i.e. in the main panel only the calibrated data for the RED, GREEN, and BLUE channels are displayed. Evaluation by the micro-controller also is exclusively done with the calibrated data.

In the following the individual steps for calibrating the sensors are described:

INFO: The individual pop-up windows are intended as a help to guide you through the calibration process.

ATTENTION: It is a prerequisite for successful calibration that the sensor front-end is calibrated to a white surface.

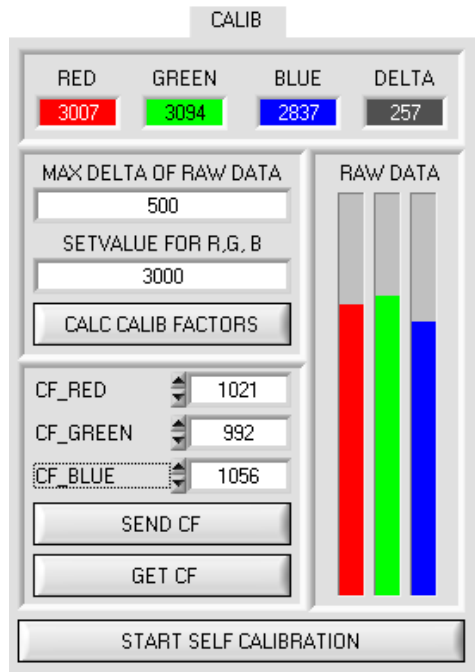

Step 1:

First of all a suitable **POWER** value must be found such that the **RAW DATA** for RED, GREEN and BLUE lie in the dynamic range (upper third of the bar display).

Step 2:

When you have set a suitable **POWER** value, determine a **SETVALUE FOR R,G,B**. The software now calculates the calibration factors in such a way that this **SETVALUE** is reached for the raw data (see calculation example above).

Step 3:

Determine a **MAX DELTA OF RAW DATA** (the software suggests 500).

Calibration is only permitted, if the current **DELTA** of the **RAW DATA** is smaller than the **MAX DELTA OF RAW DATA**.

DELTA is the maximum of **RED**, **GREEN**, and **BLUE**, minus the minimum of **RED**, **GREEN**, and **BLUE**. This is necessary in order to ensure that the sensor functions properly and calibration is performed on a white surface.

Step 4:

Start calibration by pressing **CALC CALIB FACTORS**.

The button starts to flash in red, and at the same time 100 raw data are recorded through the interface, of which the respective mean value of **RED**, **GREEN**, and **BLUE** is formed.

The individual calibration factors are formed from these mean values and from the **SETVALUES FOR R,G,B** and they are then entered in the corresponding edit-boxes.

The calibration software automatically saves the calculated calibration factors to the EEPROM of the sensor.

Then the software changes to the GO mode and displays the **RAW DATA** and the calibrated data in the main panel.

Please note that the values for **RED**, **GREEN**, and **BLUE** in the main panel approximately are equal to the value of **SETVALUE**.

You may also change the calibration factors **CF_RED**, **CF_GREEN**, **CF_BLUE** manually by entering new values in the corresponding input fields. Please note that these factors are saved to the EEPROM by pressing **SEND CF**. **GET CF** reads the calibration factors that are currently saved in the EEPROM.

If pressing **CALC CALIB FACTORS** should not be successful, please follow the information provided in the pop-up windows.

Calibration only is completed successfully, if the following pop-up window is displayed:

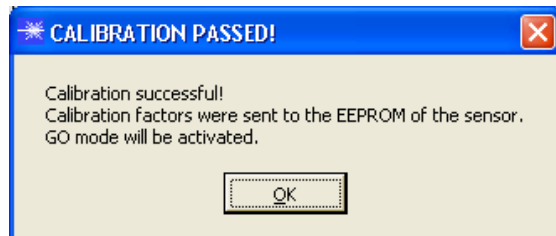

A click on **START SELF CALIBRATION** causes the sensor to calculate the calibration factors itself. It is not possible to specify a **SETVALUE** and a **MAX DELTA** here.

When the sensor has calculated the calibration factors, it displays them on the software interface. In the corresponding input fields it also displays the **SETVALUE** that it used for calculation and the **MAX DELTA** value that resulted from calculation. The **SEND CF** button must be pressed to confirm the calculated calibration factors.

2.7.2 Offset calibration

To avoid an increase of the electronic offset when using the integral function (**INTEGRAL** parameter), this offset can be eliminated by way of offset calibration or zero-point calibration. The corresponding tab is password-protected to prevent inadvertent incorrect settings.

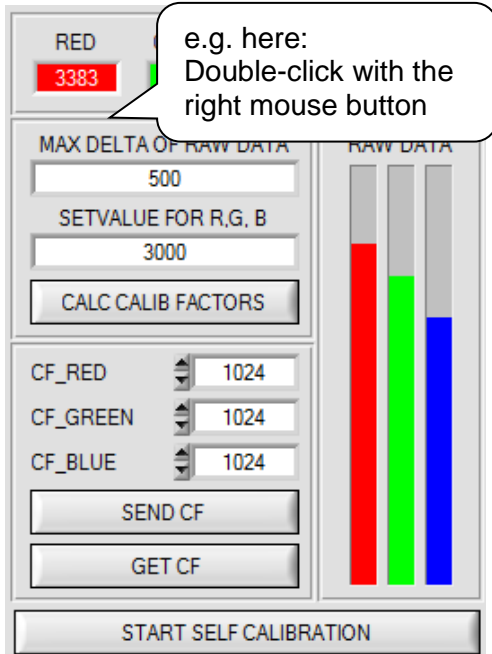

Offset calibration can be accessed by double-clicking with the right mouse button exactly at the frame in the **CALIB** tab.

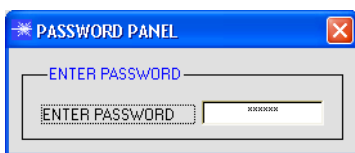

You will then be prompted to enter a password. The password is: mellon

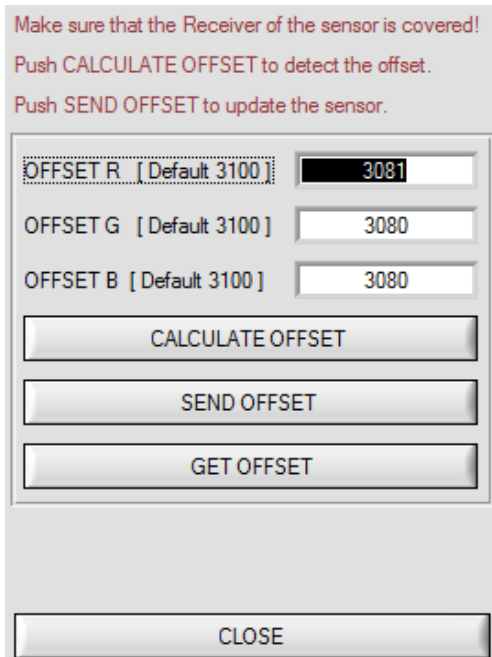

Now please follow the instructions provided in the tab.

ATTENTION!

It is extremely important for offset calibration that the receiver is not exposed to any extraneous light. Please make sure that you cover the receiver of the sensor e.g. with a black cloth that is impervious to light.

This is absolutely necessary for proper offset calculation.

Now press **CALCULATE OFFSET**. The offset values for red, green, and blue should be approximately 3080 plus/minus 40.

The offset values can then be sent to the sensor by pressing **SEND OFFSET**.

GET OFFSET can be used to check whether the data have been sent.

2.8 Tab SCOPE

The SCOPE tab visualises an oscilloscope.

TRIG MODE now optionally displays the signals **R G B**, **X Y INT** or **s i M**, the output analog signal (depending on the setting in **ANA OUT**), or the status of the digital outputs.

A click on **GET CYCLE TIME** displays the current sensor scan frequency in **[Hz]** and **[ms]**. The current scan frequency must be determined for the correct calculation of **deltaX[ms]**. For determining the correct scan frequency please give the sensor a time of 8 seconds before you click on **GET CYCLE TIME**.

In **TRIG MODE = SINGLE SHOT** a data frame is recorded and displayed in the graph when you click on **SCAN**.

In **TRIG MODE = FALLING EDGE** and **RIISING EDGE** triggered recording can be started by clicking on **SCAN**. A trigger start can be defined with **TRIGGER LEVEL**.

Triggering is performed either to **BLUE**, **INT** or **M**, depending on the signal that should be recorded. In the graph this is the blue line.

In **TRIG MODE = INTERN C-No.0** recording starts automatically when C-No. 0 is detected. **TRIG MODE= EXTERN IN0** can be used to start recording externally through input IN0.

SCAN-RATE can be used to delay or accelerate recording. This corresponds with the **TIMEBASE** function known in oscilloscopes. **PRE TRIGGER VALUES** can be used to define how many values should still be displayed before the actual trigger start.

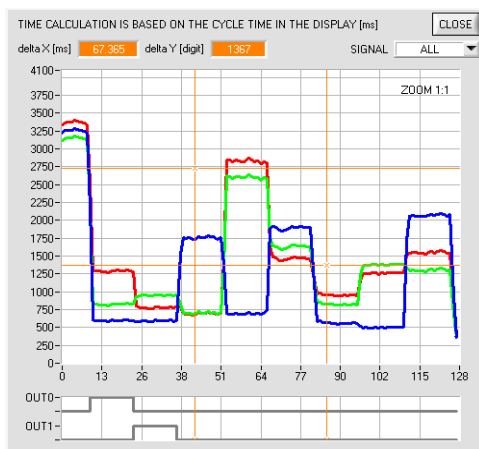
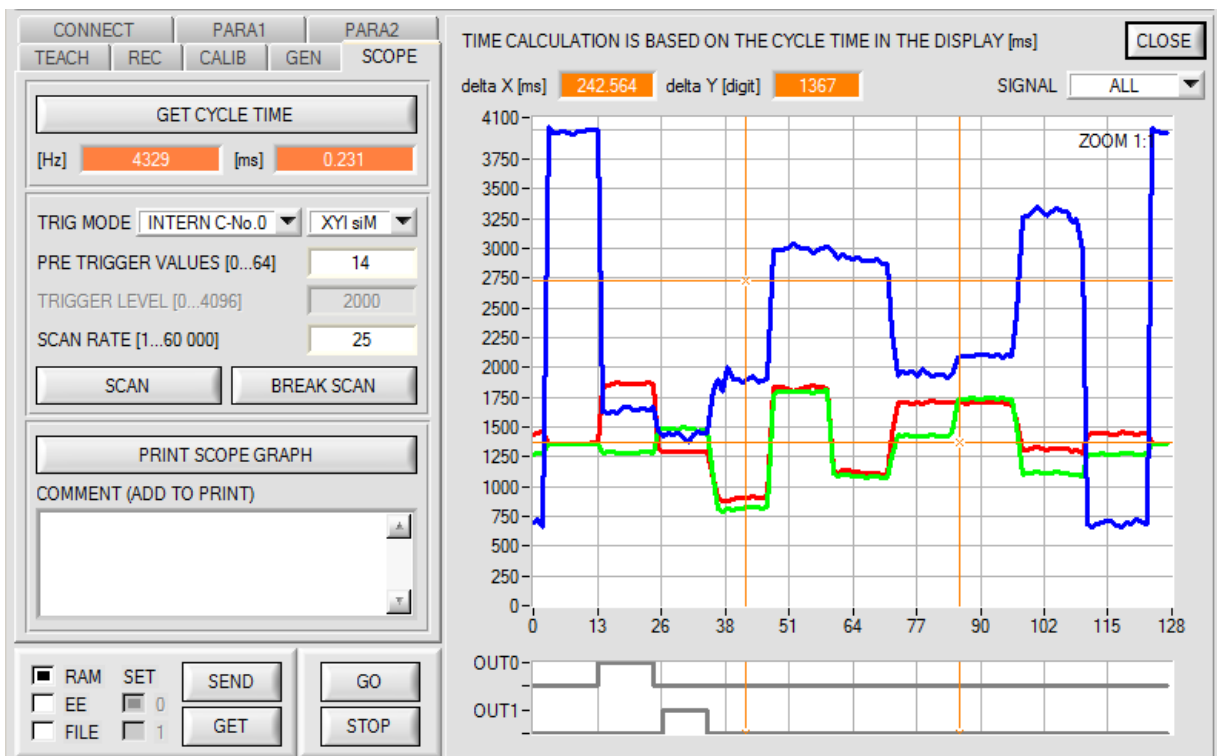

The zoom function in the graph can be activated by holding the control key (CTRL) and drawing a window with the mouse. A click on **ZOOM 1:1** cancels the zoom function again.

The two orange cursors can be moved with the mouse. The two displays **deltaX[ms]** and **deltaY[digit]** will be updated. **deltaX[ms]** shows the time between the cursors in X direction. **deltaY[digit]** shows the difference between the two cursors in digits or in Volt in Y direction.

SIGNAL can be used to display individual curves.

PRINT SCOPE GRAPH prints the current screen together with the text in the **COMMENT** text field.

2.9 Graphic display elements

RGB tab:

Display of the current raw signals of the 3-fold receiver (red, green, blue).

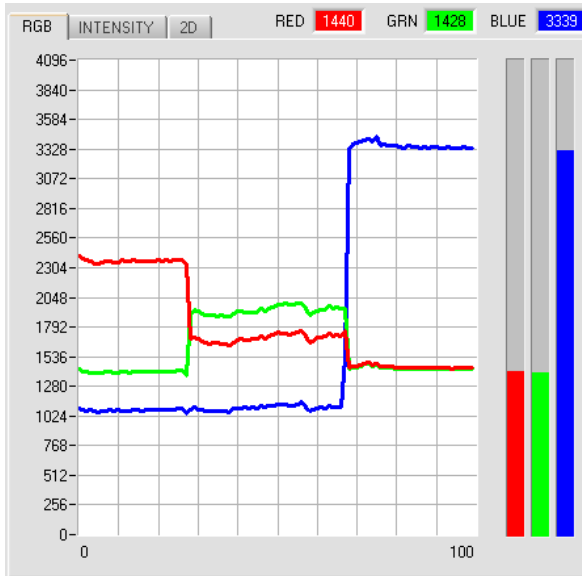

INTENSITY tab:

Display of the currently determined intensity of X, Y, INT or s, i, M.

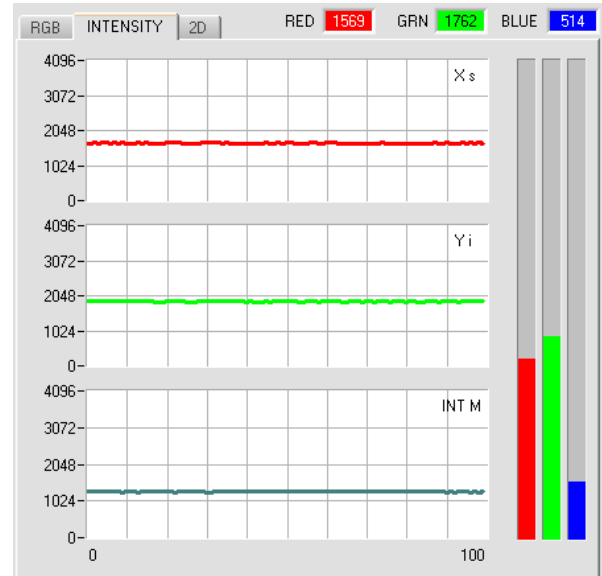

2D tab:

Display of X/Y or s/i pairs in a zoomed graph. The intensity INT or M with the tolerance window set under No.: is shown directly below this.

2D view of the color cylinder in space.

If you double-click with the left mouse button, all the circles will be shown in gray, and only the circle of the detected color will be shown in color.

With a single mouse click you can return to the normal view.

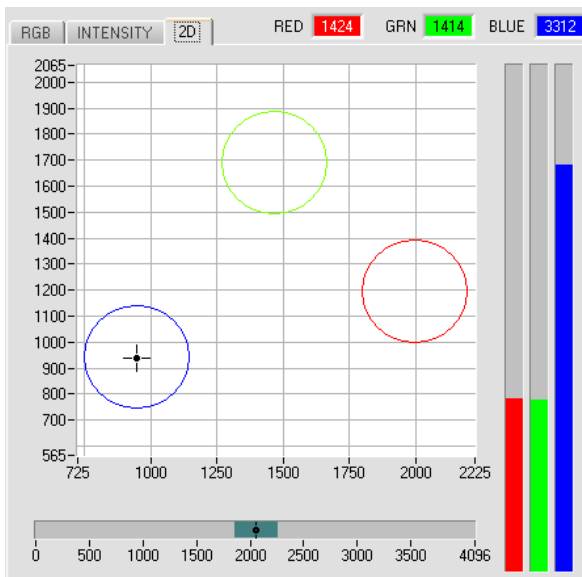

3D tab:

Display of the taught color spheres and of the current color position. A 3D view with the graphs X/Y (s/i), X/INT (s/M) and Y/INT (i/M) was chosen for the purpose of improved representation.

If you double-click with the left mouse button, all the circles will be shown in gray, and only the circle of the detected color will be shown in color.

With a single mouse click you can return to the normal view.

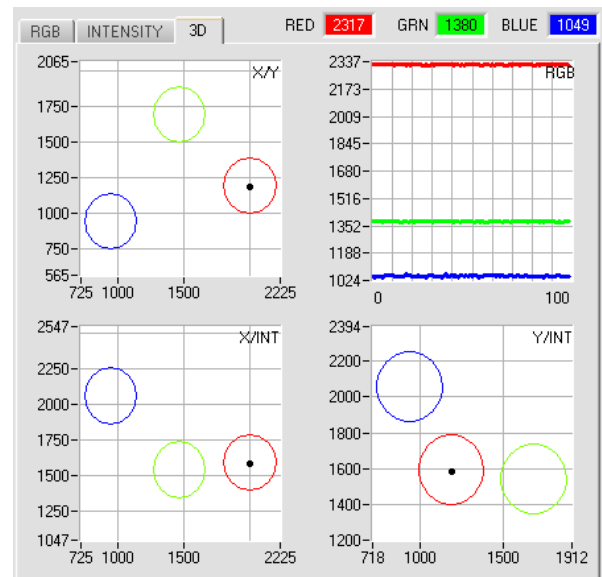

TEMP 27

TEMP:

This display shows the temperature prevailing in the sensor housing.
 The display **DOES NOT** show degrees Centigrade or Fahrenheit.

delta C
-1

delta C:

This display (delta color) shows the deviation from a color hit, **delta C** corresponds with ΔE that is calculated in a color measurement.

In **FIRST HIT** evaluation mode **delta C** represents the distance from a color hit. When no color has been hit, **delta C** is calculated in relation to the last valid color in the color table (depending on **MAXCOL-No.**).

In **BEST HIT** and **MIN DIST** evaluation mode **delta C** also represents the distance from a color hit. If, however, no color has been recognised, **delta C** assumes the value of -1.

In **COL5** evaluation mode **delta C** is not calculated.

When the current intensity (**INT** or **M**) falls below the **INTLIM** parameter, **delta C=-1** will be displayed.

In **CALCULATION MODE "X Y INT - 2D"** and **"s i M - 2D"** **delta C** represents the distance from the cylinder axis and is calculated as follows:

$$\text{deltaC} = \sqrt{X^2 + Y^2} \quad \text{or} \quad \text{deltaC} = \sqrt{s^2 + i^2}$$

In **CALCULATION MODE "X Y INT - 3D"** and **"s i M - 3D"** **delta C** represents the distance from the centre of the sphere and is calculated as follows:

$$\text{deltaC} = \sqrt{X^2 + Y^2 + INT^2} \quad \text{or} \quad \text{deltaC} = \sqrt{s^2 + i^2 + M^2}$$

3. Short instructions for the operation of color sensors with the SPECTRO3-ANA-Scope V2.0 software

These instructions describe how to perform quick teaching of the color sensors of SPECTRO-3-ANA series with the **SPECTRO3-ANA-Scope V2.0** software interface.

Basically there are 2 methods of teaching a color. These methods can be set with **CALCULATION MODE**.

The **CALCULATION MODE "X Y INT - 3D"** (or "**s i M - 3D**") uses a **color sphere** in space with radius **TOL**. Contrary to this, the **CALCULATION MODE "X Y INT - 2D"** (or "**s i M - 2D**") uses a **color cylinder** in space with radius **CTO** or **siTO** and with height **ITO** or **M**.

The teach process is the same for both methods.
 Color evaluation according to "**s i M - 2D**" uses the Lab calculation method.

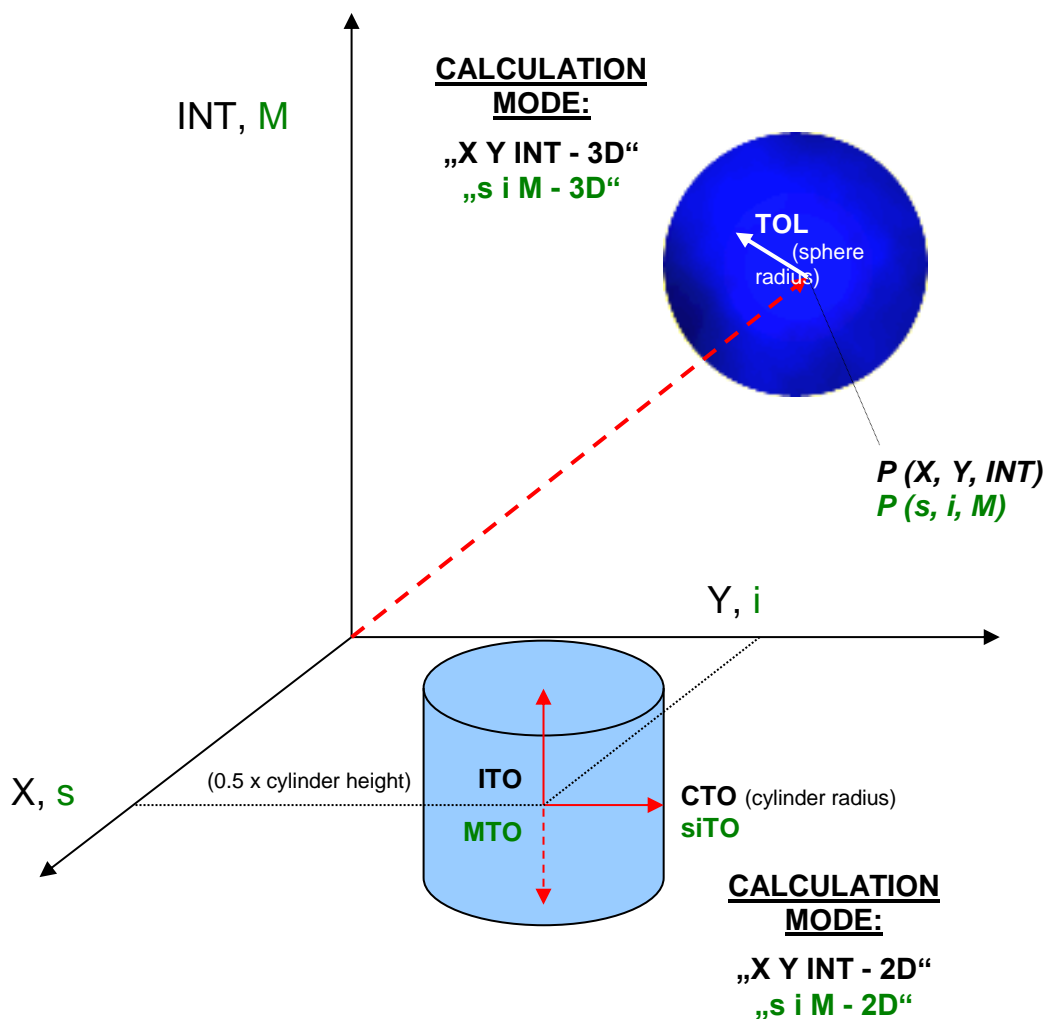

The text below describes a teach process with **EVALUATION MODE = BEST HIT** and **CALCULATION MODE = "X Y INT - 3D"**.

Step 1:

Prior to the use of the software aids (graphic display of sensor signals) the sensor must be manually adjusted to the respective target or background as accurately as possible. The reference distance of the sensor to the target is defined in the data sheet of the respective sensor.

Please make sure that the sensor is properly connected and supplied with power. Furthermore the sensor head must be directed onto the brightest surface (paper, leather, glass, etc.) of the color to be taught. This is absolutely necessary for being able to set a suitable **POWER** value for the sensor.

Step 2:

Start the SPECTRO3-ANA-Scope V2.0 software. Please check whether the status line at the right bottom displays the "SPECTRO3-ANA V2.0 xx xxx xx xxxx " message.

Info: Moving the mouse cursor to a control element and clicking with the right mouse button displays a short info on the respective individual control element.

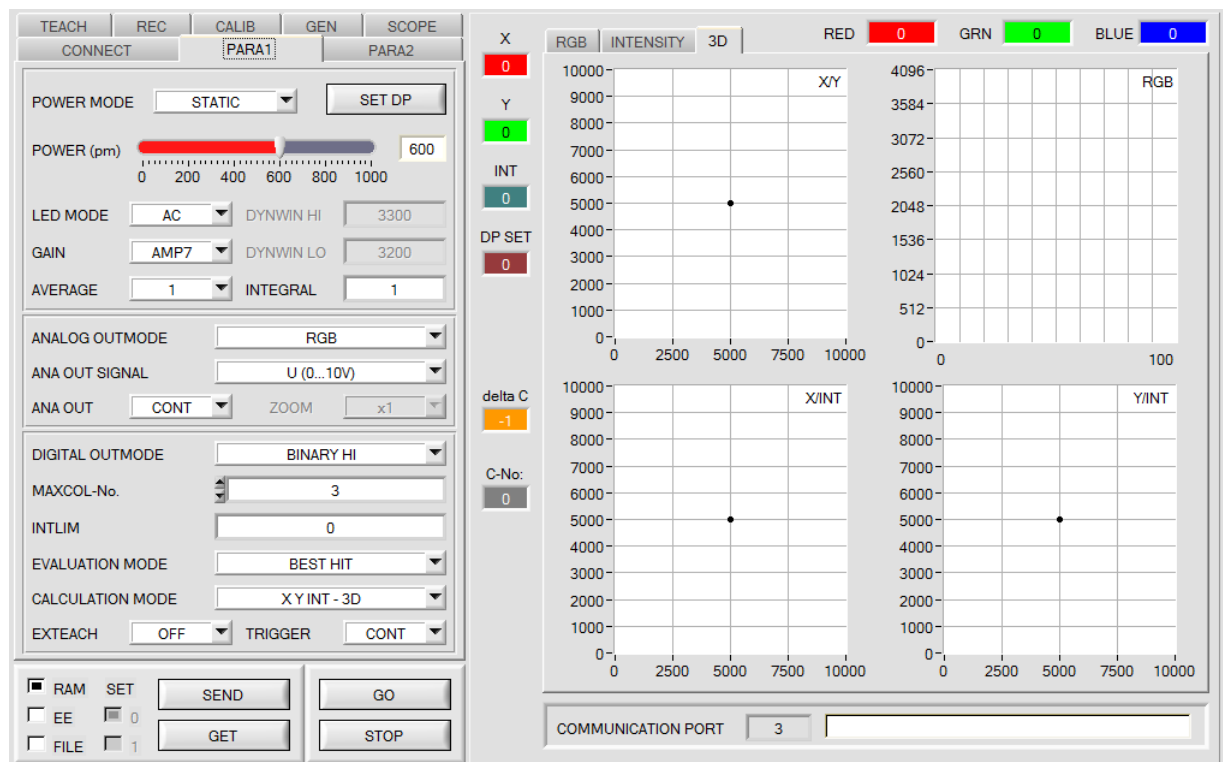

Step 3:

Please make sure that for the time being **RAM** and not **EEPROM** is selected for the data exchange with the sensor (RAM is a volatile memory in the sensor, i.e. the data will be lost when power is turned off. EEPROM is a non-volatile memory in the sensor, i.e. the data will not be lost when power is turned off.)

All the other parameters should be set as shown in the picture below. Press the tab **PARA1** to show the parameters. (See the **FILE** function in the operating instructions for SPECTRO3-ANA-Scope.)

Now press the **GO** button. Data exchange between sensor and PC will then start. The contents for **RED**, **GREEN**, and **BLUE** that are diffusely reflected from the surface are represented as a graph and as displays on the software interface.

Set the **POWER** value and **GAIN** such that at least one of the three channels of the brightest color that should be taught lies in the upper third of its dynamic range, but none is in saturation. Ideally **POWER** and **GAIN** are set in such a way that **POWER** lies in the range of 300 to 900.

ATTENTION: The sensor must be informed when you have changed the **POWER** or **GAIN** value. Press the **SEND** button to send this information to the sensor. Check the bars by pressing **GO** again. Repeat this process until you have a suitable **POWER** value and **GAIN**.

Optimally the three bars should be at approximately the same level on white paper.

If the bars vary too much, you need to perform white light balancing.

(For white light balancing see the SPECTRO3-ANA-Scope operation instructions on the supplied CD.)

Tip! There is a trick for finding a suitable **POWER** value in no time at all. Show the sensor the brightest color that should be taught, and set **POWER MODE = DYNAMIC**. The sensor then tries to find a suitable **POWER** value. Check this by pressing **GO**. Press **STOP** when the channels have "levelled out". Then press **GET**. The **POWER** value that was found now is shown in the **POWER** function field. Now set **POWER MODE = STATIC**, and press **SEND**.

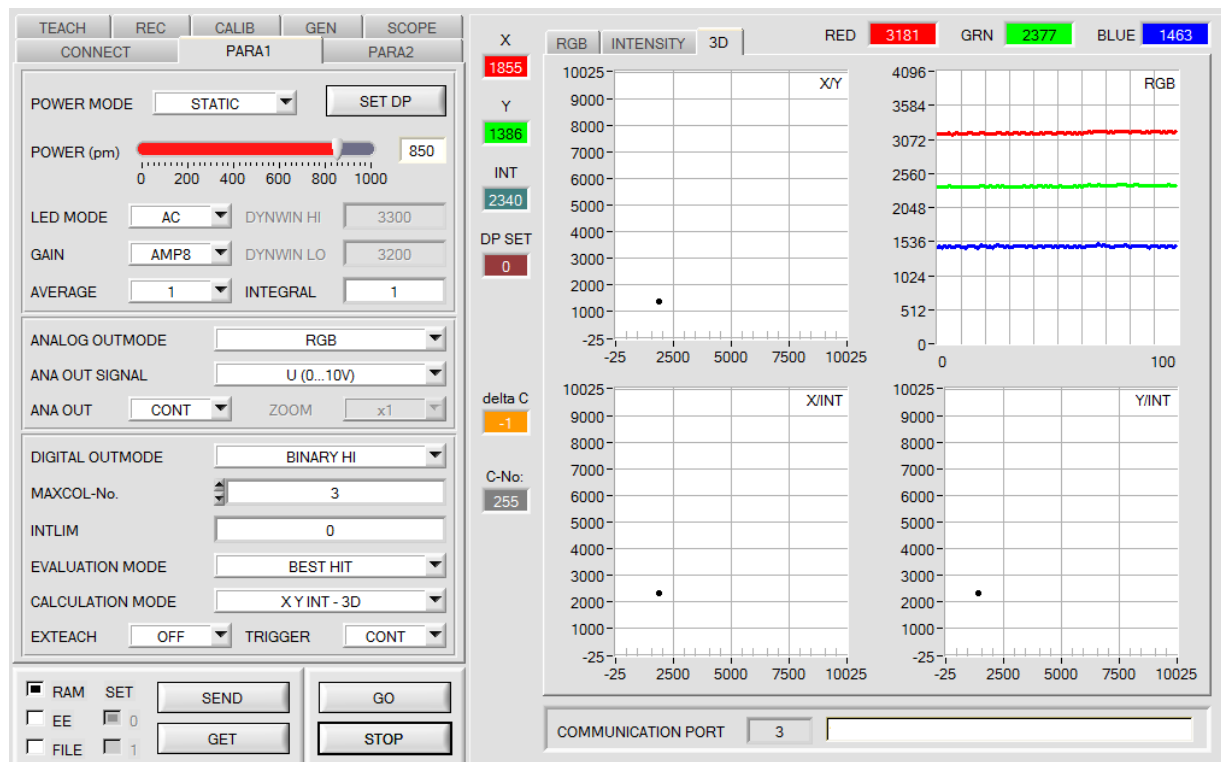

Step 4:

An **X** and a **Y** coordinate as well as an intensity **INT** are calculated from the red, green, and blue data.

$$X = (R \cdot 4095) / (R + G + B)$$

$$Y = (G \cdot 4095) / (R + G + B)$$

$$INT = (R + G + B) / 3$$

Press the **GO** button once again to read out the current data.

Press **STOP** to stop the data exchange.

Now use the **TEACH TABLE** tab to switch to the **TEACH TABLE**.

Select a row under **No.:** to which the currently present color should be taught.

(**ATTENTION:** Only the rows marked with green numbers are evaluated by the sensor. If you want to teach more colors, use the **MAXCOL-No.** parameter to select how many colors you want to teach.)

Now press the **TEACH DATA TO** button. The calculated values for **X**, **Y**, and **INT** are transferred to the **TEACH TABLE** in the row that was selected under **No.:**

The graphic displays show a 3D view of a color sphere in space. The radius of this color sphere can be set under **TOL** (tolerance). To change the **TOL** value please double-click on the corresponding cell in the **TEACH TABLE** with the left mouse button.

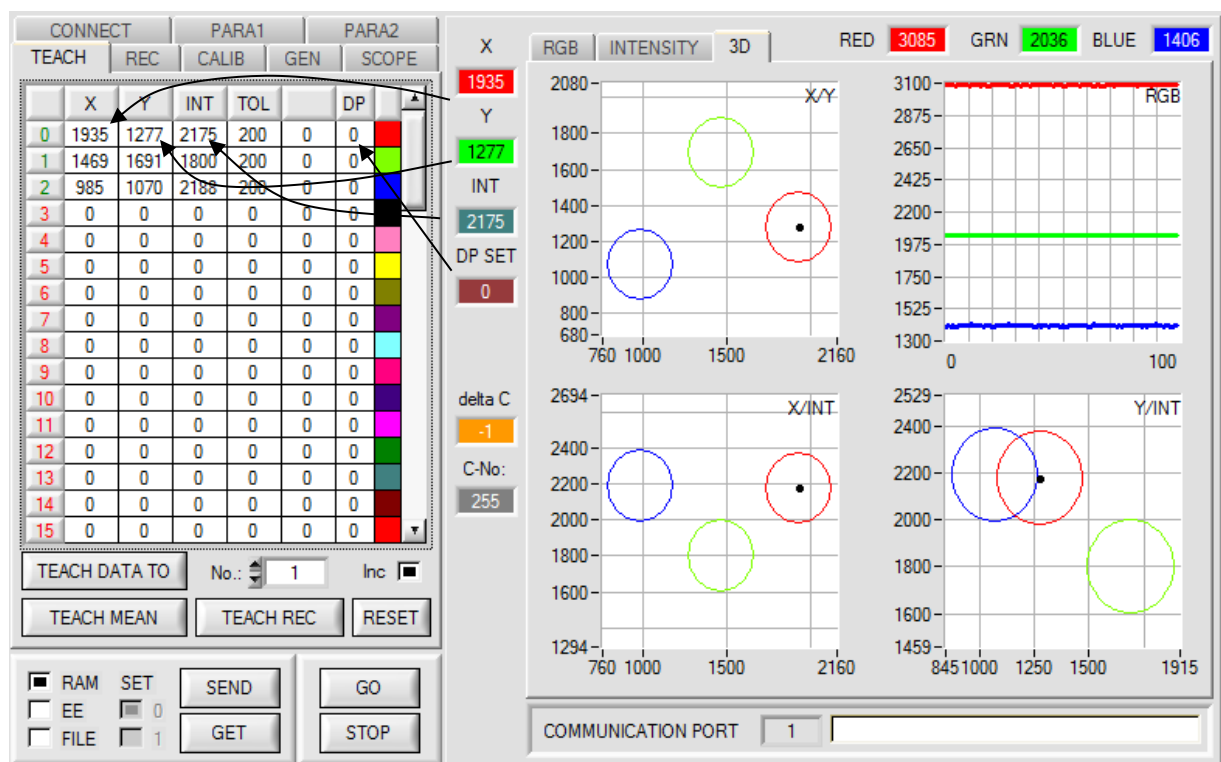

Now press the **SEND** button again to inform the sensor about the taught color. Then activate the **GO** mode again. When the sensor recognises a row vector (color), the corresponding row number is visualised on the software interface under **C-No.:**. A value of 255 means that none of the taught colors were recognised.

Step 5:

For teaching additional colors please make sure that the sensor head is directed onto the respective color. Then repeat the procedure starting from step 4.

Step 6:

When you have taught all the channels, please select **EEPROM** and press **SEND** to save the data to the non-volatile memory of the sensor.

4. Operation of the TEMPComp-Scope software

If a firmware update should go wrong and the temperature characteristics that are stored in the EEPROM should be lost, these characteristics must be created anew. For this purpose you will need a file with the corresponding data. This file can be obtained from your supplier.

To perform temperature compensation please start the corresponding **TEMPComp-Scope software** that is included on the supplied CD. Please make sure that you have a functioning sensor connection. It may be necessary to select the connection with **CONNECT**. Set the correct sensor under **SELECT SENSOR**, if this is not done automatically.

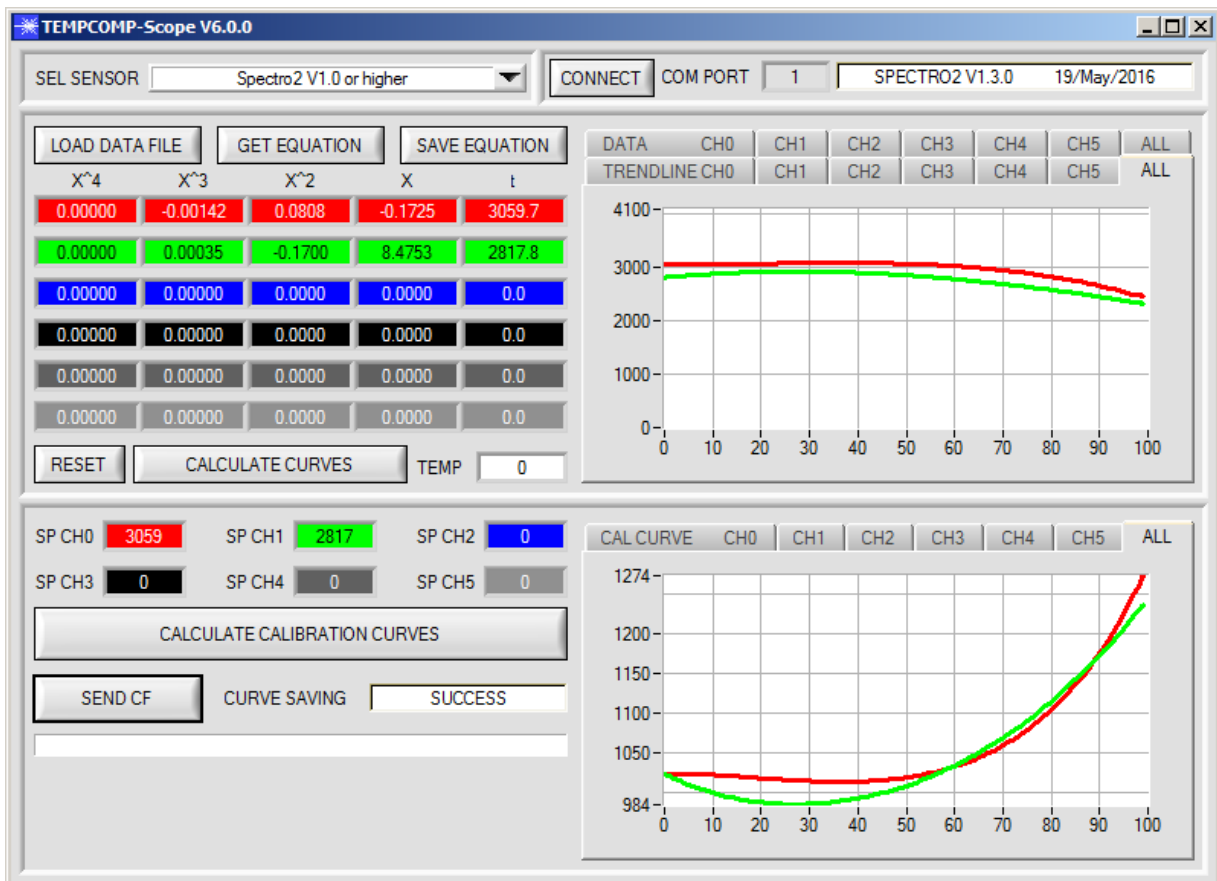

- Step 1: Load the temperature compensation file that you have received from your supplier with **GET EQUATION** or **LOAD DATA FILE**.
- Step 2: Press **CALCULATE CURVES** to display the data in the graph.
- Step 3: Select the sensor-internal operating temperature (not in °C) that the sensor has at an ambient temperature of 20°, if this has not already been done automatically. The value should be included in the file designation.
- Step 4: Press **CALCULATE CALIBRATION CURVES** to calculate the mean straight line.
- Step 5: Pressing the **SEND CF** button saves the mean straight lines in the **EEPROM** of the sensor.
- Step 6: Temperature compensation is successfully finished if the **SUCCESS** status message is then displayed.

Comment! If you do not immediately have the temperature compensation file at hand, simply start the **TempComp-Scope software**. Establish a connection, if it is not already established, and simply press **SEND-CF**. The sensor then functions as before, but it is not temperature-compensated.

5. External triggering of the SPECTRO-3-ANA color sensor

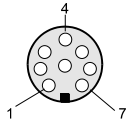

External triggering is performed through pin no. 3 (grn) at the 8-pole socket of the SPECTRO-3-ANA/PLC connection.



TRIGGER:

First the external trigger mode must be set at the color sensor. For this purpose option **EXT1**, **EXT2**, **EXT3**, **TRANS**, or **PARA** must be selected in the **TRIGGER** selection field.

PLEASE NOTE:

The new setting is only activated at the sensor after a click on the **SEND** button!

Please note: The trigger input (IN0 PIN3 green of cable cab-las8/SPS) is HIGH-active, i.e. a trigger event is detected as long as IN0 = HIGH (+24V).

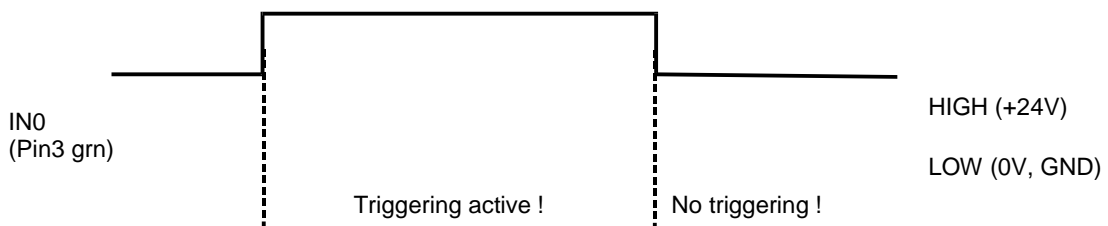

6. Connector assignment of the SPECTRO-3-ANA color sensor

Connection of SPECTRO-3-ANA to PC:

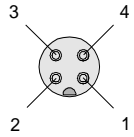
4-pole fem. M5 connector (type Binder 707) SPECTRO-3-ANA/PC-RS232		 
Pin-No.:		Assignment:
1		+24VDC (+Ub)
2		0V (GND)
3		Rx0
4		Tx0

Connection of SPECTRO-3-ANA to PLC:

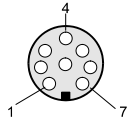
8-pole female connector (type Binder 712) SPECTRO-3-ANA/PLC		 
Pin No.:	Color:	Assignment:
1	White	0V (GND)
2	Brown	+24VDC ($\pm 10\%$) (+Ub)
3	Green	INO
4	Yellow	OUT0 (Digital 0: typ. 0 ... 1V, Digital 1: typ. +Ub – 10%)
5	Grey	OUT1 (Digital 0: typ. 0 ... 1V, Digital 1: typ. +Ub – 10%)
6	Pink	OUT2 (Analog R or X or s : 0 ... +10V or 4 ... 20mA)
7	Blue	OUT3 (Analog G or Y or i : 0 ... +10V or 4 ... 20mA)
8	Red	OUT4 (Analog B or INT or M : 0 ... +10V or 4 ... 20mA)

7. RS232 communication protocol

The sensors of the SPECTRO-3-ANA series operate with the following **parameters** that are sent to the sensor or read from the sensor in the stated sequence.

Info! 1 **bytes** = 8bit 1 **word** = 2 **byte**

A second parameter SET can be sent to the sensor. See **TRIGGER=PARA**.

Parameter	Type	Meaning
Para1: POWER	Word	Transmitter intensity (0 ... 1000) Attention intensity in thousandth!
Para2: POWER MODE	Word	Transmitter mode: STATIC, DYNAMIC, DOUBLE coded to (0, 1, 2)
Para3: AVERAGE	Word	Signal averaging 1, 2, 4, 8, 16, 32, 64, 128, 256, 512, 1024, 2048, 4096, 8192, 16384 or 32768
Para4: EVALUATION MODE	Word	Evaluation mode: FIRST HIT, BEST HIT, MIN DIST, COL5 coded to (0,1,2,3)
Para5: HOLD for C-No: 255	Word	Hold time for failure condition (C-No: 255) coded to (0...100) [ms]
Para6: INTLIM	Word	Intensity limit (0 ... 4095)
Para7: MAXCOL-No.	Word	Number of the colours (1,2,3,...,64)
Para8: DIGITAL OUTMODE	Word	Function of the digital output: OFF, DIRECT HI, BINARY, DIRECT LO coded to (0,1,2,3)
Para9: TRIGGER	Word	Trigger mode: CONT, SELF, EXT1, EXT2, EXT3, TRANS, PARA coded to (0, 1, 2, 3, 4, 5, 6)
Para10: EXTEACH	Word	External teach mode: OFF, ON, STAT1, DYN1 coded to (0,1,2,3)
Para11: CALCULATION MODE	Word	Calculation mode: „X Y INT - 2D“, „s i M - 2D“, „X Y INT - 3D“, „s i M - 3D“ coded to (0,1,2,3)
Para12: DYN WIN LO	Word	Low limit for dynamic window when POWER MODE=dynamic (0...4095)
Para13: DYN WIN HI	Word	High limit for dynamic window when POWER MODE=dynamic (0...4095)
Para14: COLOR GROUPS	Word	Color groups enable: OFF, ON coded to (0,1)
Para15: LED MODE	Word	Control for the internal light source DC, AC, OFF coded to (0,1,2)
Para16: GAIN	Word	Amplification of the integrated receiver AMP1, AMP2, AMP3, AMP4, AMP5, AMP6, AMP7, AMP8 coded to (1, 2, 3, 4, 5, 6, 7, 8)
Para17: INTEGRAL	Word	Signal integration (1...250)
Para18: ANALOG OUTMODE	Word	Function of the analogue outmode: OFF, RGB, X Y INT, s i M, RGB MM, siM REF coded to (0,1,2,3,4,5)
Para19: ANA OUT SIGNAL	Word	Function of the analog output: U, I coded to (0,1)
Para20: ANA OUT	Word	Function of analogue out: CONT, IN0 L--->H coded to (0,1)
Para21: ANA ZOOM	Word	Zoom factor at ANALOG OUTMODE = siM REF: x1, x2, x4, x8, x16, x32, x64, x128 Coded to (0,1,2,3,4,5,6,7)
Para22: POWER DP1	word	Transmitter intensity of Double Parameter Set 1 (0 ... 1000) Attention intensity in thousandth!
Para23: GAIN DP1	word	Amplification of the integrated receiver of Double Parameter Set 1 AMP1, AMP2, AMP3, AMP4, AMP5, AMP6, AMP7, AMP8 coded to (1, 2, 3, 4, 5, 6, 7, 8)
Para24: INTEGRAL DP1	word	Signal integration of Double Parameter Set1 (1...250)
Para25: POWER DP2	word	Transmitter intensity of Double Parameter Set 2 (0 ... 1000) Attention intensity in thousandth!
Para26: GAIN DP2	word	Amplification of the integrated receiver of Double Parameter Set 2 AMP1, AMP2, AMP3, AMP4, AMP5, AMP6, AMP7, AMP8 coded to (1, 2, 3, 4, 5, 6, 7, 8)
Para27: INTEGRAL DP2	word	Signal integration of Double Parameter Set2 (1...250)
Para28: COR VAL R	word	Correction Value for R
Para29: COR VAL G	word	Correction Value for G
Para30: COR VAL B	word	Correction Value for B

One row in the Teach Table, Group Table and Hold Table determines a **TEACH VECTOR**. The sensors of the SPECTRO-3-ANA series operate with **64 TEACH VECTORS** that are sent to the sensor or read from the sensor in two blocks in the stated sequence. Additional **64 TEACH VECTORS** can be sent as a second SET. See **TRIGGER=PARA**.
 Info! 1 **bytes** = 8bit 1 **word** = 2 **byte**

TEACH VECTOR		Type	Meaning
TeachVal1:	Teach Table Row 0 Column 0	Word	X respectively s of row 0
TeachVal2:	Teach Table Row 0 Column 1	Word	Y respectively i of row 0
TeachVal3:	Teach Table Row 0 Column 2	Word	CTO or INT respectively M of row 0
TeachVal4:	Teach Table Row 0 Column 3	Word	INT respectively M or TOL of row 0
TeachVal5:	Teach Table Row 0 Column 4	Word	ITO or free of row 0
TeachVal6:	Group Table Row 0	Word	Group to which row 0 belongs if enabled
TeachVal7:	Hold Table Row 0	Word	Hold time for row 0
TeachVal8:	Free	Word	Send 0 as dummy
TeachVal9:	Teach Table Row 1 Column 0	Word	X respectively s of row 1
TeachVal10:	Teach Table Row 1 Column 1	Word	Y respectively i of row 1
TeachVal11:	Teach Table Row 1 Column 2	Word	CTO or INT respectively M of row 1
...
TeachVal512	Free	Word	Send 0 as dummy

Upon request, the data acquired and processed by the sensor are sent by the sensor in the following sequence.

DATA VALUE	Type	Meaning
DatVal1: RED	Word	Calibrated and temperature compensated signal from channel red
DatVal2: GREEN	Word	Calibrated and temperature compensated signal from channel green
DatVal3: BLUE	Word	Calibrated and temperature compensated signal from channel blue
DatVal4: X resp. s	Word	Calculated X respectively s value
DatVal5: Y resp. i	Word	Calculated Y respectively i value
DatVal6: INT resp. M	Word	Calculated INT respectively M value
DatVal7: delta C	Word	Distance to a color hit
DatVal8: C-No:	Word	Detected color
DatVal9: GRP	Word	Detected group
DatVal10: TRIG	Word	TRIG is 1 when a trigger condition is given
DatVal11: TEMP	Word	Temperature in the sensor (not in °C or °F)
DatVal12: RAW RED	Word	None Calibrated and none temperature compensated signal from channel red
DatVal13: RAW GREEN	Word	None Calibrated and none temperature compensated signal from channel green
DatVal14: RAW BLUE	Word	None Calibrated and none temperature compensated signal from channel blue
DatVal15: MIN RED	Word	Calibrated and temperature compensated minimum signal from channel red
DatVal16: MIN GREEN	Word	Calibrated and temperature compensated minimum signal from channel green
DatVal17: MIN BLUE	Word	Calibrated and temperature compensated minimum signal from channel blue
DatVal18: MAX RED	Word	Calibrated and temperature compensated maximum signal from channel red
DatVal19: MAX GREEN	Word	Calibrated and temperature compensated maximum signal from channel green
DatVal20: MAX BLUE	Word	Calibrated and temperature compensated maximum signal from channel blue
DatVal21: REF s	Word	Reference Value when ANALOG OUTMODE = sim REF
DatVal22: REF i	Word	Reference Value when ANALOG OUTMODE = sim REF
DatVal23: REF M	Word	Reference Value when ANALOG OUTMODE = sim REF
DatVal24: DP SET	Word	Double Parameter Set

Digital serial communication is used for the exchange of data between the software running on the PC and the sensor.

For this purpose the control unit features an EIA-232 compatible interface that operates with the (fixed) parameters **"8 data bits, 1 stop bit, no parity bit, no handshake"**.

Five values are available for the baudrate: 9600baud, 19200baud, 38400baud, 57600baud and 115200baud. As an option the PC software also can communicate through TCP/IP or USB. In these cases transparent interface converters must be used that allow a connection to the RS232 interface.

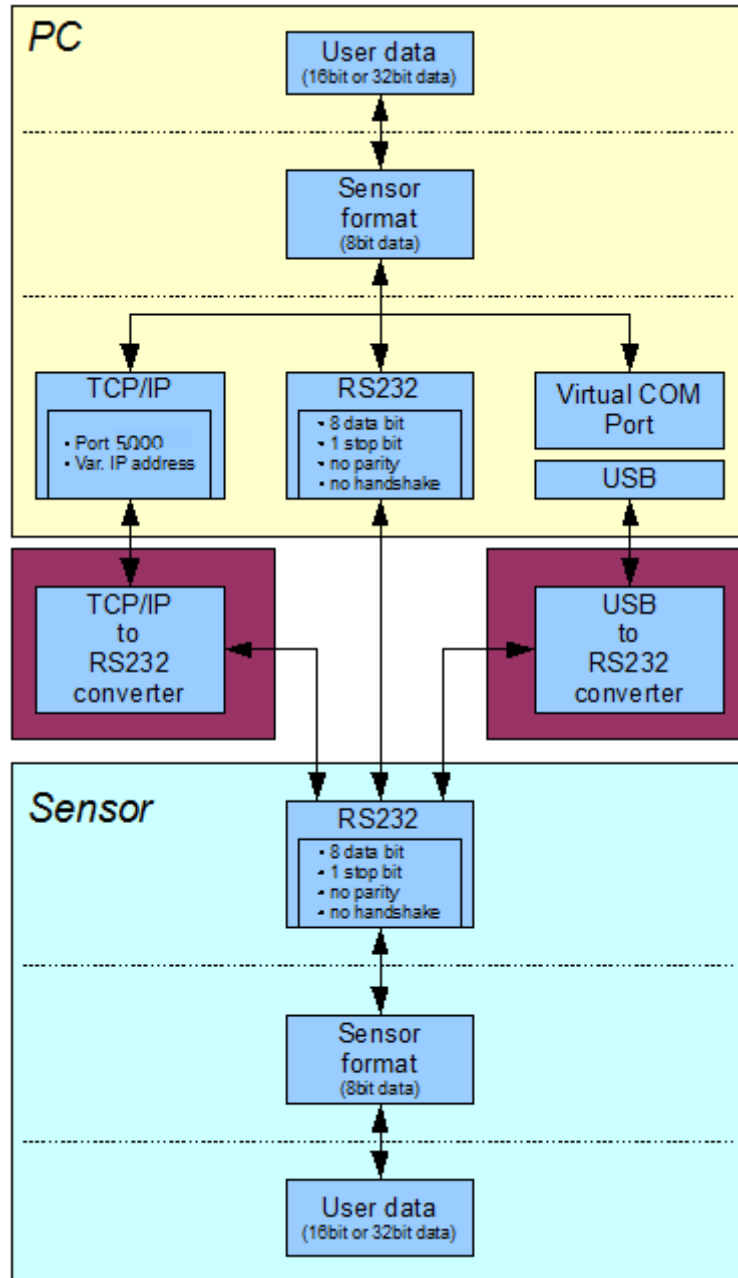

A proprietary protocol format that organises and bundles the desired data is used for all physical connection variants between PC software and control unit. Depending on their type and function the actual data are 16- or 32-bit variables and represent integer or floating-point values. The protocol format consists of 8-bit wide unsigned words ("bytes"). The actual data therefore sometimes must be distributed to several bytes.

The control unit always behaves passively (except if another behaviour has been specifically activated). Data exchange therefore always is initiated by the PC software. The PC sends a data package ("frame") corresponding to the protocol format, either with or without appended data, to which the control unit responds with a frame that matches the request.

The protocol format consists of two components:

A "header" and an optional appendant ("data").

The header always has the same structure.

The first byte is a synchronisation byte and always is 85_{dez} (55_{hex}).

The second byte is the so-called order byte. This byte determines the action that should be performed (send data, save data, etc.).

A 16-bit value (argument) follows as the third and fourth byte. Depending on the order, the argument is assigned a corresponding value.

The fifth and sixth byte again form a 16-bit value. This value states the number of appended data bytes. Without appended data both these bytes are 0_{dez} or 00_{hex}, the maximum number of bytes is 512.

The seventh byte contains the CRC8 checksum of all data bytes (data byte 0 up to and incl. data byte n).

The eighth byte is the CRC8 checksum for the header and is formed from bytes 0 up to and incl. 6.

The header always has a total length of 8 bytes. The complete frame may contain between 8 and 520 bytes.

Byte0 Header	Byte1 Header	Byte2 Header	Byte3 Header	Byte4 Header	Byte5 Header	Byte6 Header	Byte7 Header	Byte8 Data	Byte9 Data	...	Byte n+6 Data	Byte n+7 Data
0x55	<order>	<ARG> (lo byte)	<ARG> (hi byte)	<LEN> (lo byte)	<LEN> (hi byte)	CRC8 (Data)	CRC8 (Header)	Data1 (lo byte)	Data1 (hi byte)	...	Data n/2 (lo byte)	Data n/2 (hi byte)

The following **orders** can be sent to the sensor.

Number	ORDER (header byte no. 2)	Example
0	Sensor answers with order=0 if a communication error occurs. ARG=1: Invalid order number was sent to the sensor ARG=2: General communication error (wrong baudrate, overflow, ...)	
1	Write parameter to the RAM of the sensor	order=1
2	Read parameter from the RAM of the sensor	order=2
3	Load parameter and actual Baudrate from RAM to EEPROM of the sensor	order=3
4	Load parameter from EEPROM to RAM of the sensor	order=4
5	Read CONNECTION OK and serial number from sensor	order=5
6	Free	
7	Read Firmware String and firmware number from sensor	order=7
8	Read data values from sensor	order=8
108	Read 3 data values from sensor	order=108
30	Start and Stop triggered sending of data frames	order=30
103	Start white light correction and get calibration factors, setvalue and max delta of raw data.	order=103
105	Get cycle time from sensor	order=105
190	Write new baud rate to the sensor	order=190

CRC8 checksum

The so-called "Cyclic Redundancy Check" or CRC is used to verify data integrity. This algorithm makes it possible to detect individual bit errors, missing bytes, and faulty frames. For this purpose a value - the so-called checksum - is calculated over the data (bytes) to be checked and is transmitted together with the data package. Calculation is performed according to an exactly specified method based on a generator polynomial. The length of the checksum is 8 bit (= 1 byte). The generator polynomial is:

$$X^8 + X^5 + X^4 + X^0$$

To verify the data after they have been received, CRC calculation is performed once again. If the sent and the newly calculated CRC values are identical, the data are without error.

The following pseudo code can be used for checksum calculation:

calcCRC8 (data[], table[])

Input: data[], n data of unsigned 8bit
 table[], 256 table entries of unsigned 8bit

Output: crc8, unsigned 8bit

```

crc8 := AAhex
for I := 1 to n do
    idx := crc8 EXOR data[ i ]
    crc8 := table[ idx ]
endfor
return crc8
    
```

table[]

0	94	188	226	97	63	221	131	194	156	126	32	163	253	31	65
157	195	33	127	252	162	64	30	95	1	227	189	62	96	130	220
35	125	159	193	66	28	254	160	225	191	93	3	128	222	60	98
190	224	2	92	223	129	99	61	124	34	192	158	29	67	161	255
70	24	250	164	39	121	155	197	132	218	56	102	229	187	89	7
219	133	103	57	186	228	6	88	25	71	165	251	120	38	196	154
101	59	217	135	4	90	184	230	167	249	27	69	198	152	122	36
248	166	68	26	153	199	37	123	58	100	134	216	91	5	231	185
140	210	48	110	237	179	81	15	78	16	242	172	47	113	147	205
17	79	173	243	112	46	204	146	211	141	111	49	178	236	14	80
175	241	19	77	206	144	114	44	109	51	209	143	12	82	176	238
50	108	142	208	83	13	239	177	240	174	76	18	145	207	45	115
202	148	118	40	171	245	23	73	8	86	180	234	105	55	213	139
87	9	235	181	54	104	138	212	149	203	41	119	244	170	72	22
233	183	85	11	136	214	52	106	43	117	151	201	74	20	246	168
116	42	200	150	21	75	169	247	182	232	10	84	215	137	107	53

Example order=1: Write parameter to the RAM of the sensor.

<ARG> determines whether you want to save parameter or teach vectors:

ARG = 0 --> Parameter Set 0

ARG = 1 --> Parameter Set 1

ARG = 2 --> Teach Vector Set 0 Row 0...31

ARG = 3 --> Teach Vector Set 0 Row 32..63

ARG = 4 --> Teach Vector Set 1 Row 0...31

ARG = 5 --> Teach Vector Set 2 Row 32..63

Example is with 5 parameter (Para1=500, Para2=0; Para3=3200, Para4=3300, Para5=1)

Have a look at the **TABLE PARAMETER** to check out how much parameter you have to send.

DATA FRAME PC → Sensor for Parameter Set 0

Byte1 Header	Byte2 Header	Byte3 Header	Byte4 Header	Byte5 Header	Byte6 Header	Byte7 Header	Byte8 Header	
0x55	<order>	<ARG> (lo byte)	<ARG> (hi byte)	<LEN> (lo byte)	<LEN> (hi byte)	CRC8 (Data)	CRC8 (Header)	
85 (dec)	1	0	0	10	0	130	107	
ARG=0			LEN=10					

Byte9 Data	Byte10 Data	Byte11 Data	Byte12 Data	Byte13 Data	Byte14 Data	Byte15 Data	Byte16 Data	Byte17 Data	Byte18 Data
Para1 (lo byte)	Para1 (hi byte)	Para2 (lo byte)	Para2 (hi byte)	Para3 (lo byte)	Para3 (hi byte)	Para4 (lo byte)	Para4 (hi byte)	Para5 (lo byte)	Para5 (hi byte)
244	1	0	0	128	12	228	12	1	0
Para1=500		Para2=0		Para3=3200		Para4=3300		Para5=1	

DATA FRAME Sensor → PC

Byte1 Header	Byte2 Header	Byte3 Header	Byte4 Header	Byte5 Header	Byte6 Header	Byte7 Header	Byte8 Header	
0x55	<order>	<ARG> (lo byte)	<ARG> (hi byte)	<LEN> (lo byte)	<LEN> (hi byte)	CRC8 (Data)	CRC8 (Header)	
85 (dec)	1	0	0	0	0	170	224	
ARG=0			LEN=0					

If you receive an argument greater 0, ARG parameter where out of range and have been set to a default value.

Example order=2: Read parameter from the RAM of the sensor.

<ARG> determines whether you want to read parameter or teach vectors:

- ARG = 0 --> Parameter Set 0
- ARG = 1 --> Parameter Set 1
- ARG = 2 --> Teach Vector Set 0 Row 0...31
- ARG = 3 --> Teach Vector Set 0 Row 32..63
- ARG = 4 --> Teach Vector Set 1 Row 0...31
- ARG = 5 --> Teach Vector Set 2 Row 32..63

Example is with 5 parameter (Para1=500, Para2=0; Para3=3200, Para4=3300, Para5=1)
 Have a look at the **TABLE PARAMETER** to check out how much parameter you will receive.

DATA FRAME PC → Sensor

Byte1 Header	Byte2 Header	Byte3 Header	Byte4 Header	Byte5 Header	Byte6 Header	Byte7 Header	Byte8 Header
0x55	<order>	<ARG> (lo byte)	<ARG> (hi byte)	<LEN> (lo byte)	<LEN> (hi byte)	CRC8 (Data)	CRC8 (Header)
85 (dec)	2	0	0	0	0	170	185
ARG=0			LEN=0				

DATA FRAME Sensor → PC

Byte1 Header	Byte2 Header	Byte3 Header	Byte4 Header	Byte5 Header	Byte6 Header	Byte7 Header	Byte8 Header
0x55	<order>	<ARG> (lo byte)	<ARG> (hi byte)	<LEN> (lo byte)	<LEN> (hi byte)	CRC8 (Data)	CRC8 (Header)
85 (dec)	2	0	0	10	0	130	50
ARG=0			LEN=10				

Byte9 Data	Byte10 Data	Byte11 Data	Byte12 Data	Byte13 Data	Byte14 Data	Byte15 Data	Byte16 Data	Byte17 Data	Byte18 Data
Para1 (lo byte)	Para1 (hi byte)	Para2 (lo byte)	Para2 (hi byte)	Para3 (lo byte)	Para3 (hi byte)	Para4 (lo byte)	Para4 (hi byte)	Para5 (lo byte)	Para5 (hi byte)
244	1	0	0	128	12	228	12	1	0
Para1=500		Para2=0		Para3=3200		Para4=3300		Para5=1	

Example order=3: Load parameter and actual Baudrate from RAM to EEPROM of the sensor.

DATA FRAME PC → Sensor

Byte0 Header	Byte1 Header	Byte2 Header	Byte3 Header	Byte4 Header	Byte5 Header	Byte6 Header	Byte7 Header	
0x55	<order>	<ARG> (lo byte)	<ARG> (hi byte)	<LEN> (lo byte)	<LEN> (hi byte)	CRC8 (Data)	CRC8 (Header)	
85 (dec)	3	0	0	0	0	170	142	
ARG=0			LEN=0					

- DATA FRAME Sensor → PC

Byte0 Header	Byte1 Header	Byte2 Header	Byte3 Header	Byte4 Header	Byte5 Header	Byte6 Header	Byte7 Header	
0x55	<order>	<ARG> (lo byte)	<ARG> (hi byte)	<LEN> (lo byte)	<LEN> (hi byte)	CRC8 (Data)	CRC8 (Header)	
85 (dec)	3	0	0	0	0	170	142	
ARG=0			LEN=0					

Example order=4: Load parameter from EEPROM to RAM of the sensor.

DATA FRAME PC → Sensor

Byte0 Header	Byte1 Header	Byte2 Header	Byte3 Header	Byte4 Header	Byte5 Header	Byte6 Header	Byte7 Header	
0x55	<order>	<ARG> (lo byte)	<ARG> (hi byte)	<LEN> (lo byte)	<LEN> (hi byte)	CRC8 (Data)	CRC8 (Header)	
85 (dec)	4	0	0	0	0	170	11	
ARG=0			LEN=0					

DATA FRAME Sensor → PC

Byte0 Header	Byte1 Header	Byte2 Header	Byte3 Header	Byte4 Header	Byte5 Header	Byte6 Header	Byte7 Header	
0x55	<order>	<ARG> (lo byte)	<ARG> (hi byte)	<LEN> (lo byte)	<LEN> (hi byte)	CRC8 (Data)	CRC8 (Header)	
85 (dec)	4	0	0	0	0	170	11	
ARG=0			LEN=0					

Example order=5: Read CONNECTION OK from sensor.

DATA FRAME PC → Sensor

ARG determines the serial number of the sensor

Byte0 Header	Byte1 Header	Byte2 Header	Byte3 Header	Byte4 Header	Byte5 Header	Byte6 Header	Byte7 Header	
0x55	<order>	<ARG> (lo byte)	<ARG> (hi byte)	<LEN> (lo byte)	<LEN> (hi byte)	CRC8 (Data)	CRC8 (Header)	
85 (dec)	5	0	0	0	0	170	60	
ARG=0			LEN=0					

DATA FRAME Sensor → PC

Byte0 Header	Byte1 Header	Byte2 Header	Byte3 Header	Byte4 Header	Byte5 Header	Byte6 Header	Byte7 Header	
0x55	<order>	<ARG> (lo byte)	<ARG> (hi byte)	<LEN> (lo byte)	<LEN> (hi byte)	CRC8 (Data)	CRC8 (Header)	
85 (dec)	5	170	0	0	0	170	178	
ARG=170			LEN=0					

Example order=7: Read Firmware String from sensor

DATA FRAME PC → Sensor

ARG determines the firmware number of the sensor

Byte0 Header	Byte1 Header	Byte2 Header	Byte3 Header	Byte4 Header	Byte5 Header	Byte6 Header	Byte7 Header
0x55	<order>	<ARG> (lo byte)	<ARG> (hi byte)	<LEN> (lo byte)	<LEN> (hi byte)	CRC8 (Data)	CRC8 (Header)
85 (dec)	7	0	0	0	0	170	82
ARG=0				LEN=0			

DATA FRAME Sensor → PC

Byte0 Header	Byte1 Header	Byte2 Header	Byte3 Header	Byte4 Header	Byte5 Header	Byte6 Header	Byte7 Header	Byte8 Data	Byte9 Data	Byte10 Data	Byte11 Data
0x55	<order>	<ARG> (lo byte)	<ARG> (hi byte)	<LEN> (lo byte)	<LEN> (hi byte)	CRC8 (Data)	CRC8 (Header)	ASCII	ASCII	ASCII	ASCII
85 (dec)	7	0	0	72	0	183	38	F	I	R	M
ARG=0				LEN=72							

Byte12 Data	Byte13 Data	Byte14 Data	Byte15 Data	Byte16 Data	Byte17 Data	Byte18 Data	Byte19 Data	Byte20 Data	Byte21 Data	Byte22 Data	Byte23 Data
ASCII	ASCII	ASCII	ASCII	ASCII	ASCII	ASCII	ASCII	ASCII	ASCII	ASCII	ASCII
W	A	R	E		S	T	R	I	N	G	

Byte24 Data	Byte25 Data	Byte26 Data	Byte27 Data	Byte28 Data	Byte29 Data	Byte30 Data	Byte31 Data	Byte32 Data	Byte33 Data	Byte34 Data	Byte35 Data
ASCII	ASCII	ASCII	ASCII	ASCII	ASCII	ASCII	ASCII	ASCII	ASCII	ASCII	ASCII
											R

Byte36 Data	Byte37 Data	Byte38 Data	Byte39 Data	Byte40 Data	Byte41 Data	Byte42 Data	Byte43 Data	Byte44 Data	Byte45 Data	Byte46 Data	Byte47 Data
ASCII	ASCII	ASCII	ASCII	ASCII	ASCII	ASCII	ASCII	ASCII	ASCII	ASCII	ASCII
T	:	K	W	x	x	/	x	x			

Byte48 Data	Byte49 Data	Byte50 Data	Byte51 Data	Byte52 Data	Byte53 Data	Byte54 Data	Byte55 Data	Byte56 Data	Byte57 Data	Byte58 Data	Byte59 Data
ASCII	ASCII	ASCII	ASCII	ASCII	ASCII	ASCII	ASCII	ASCII	ASCII	ASCII	ASCII

Byte60 Data	Byte61 Data	Byte62 Data	Byte63 Data	Byte64 Data	Byte65 Data	Byte66 Data	Byte67 Data	Byte68 Data	Byte69 Data	Byte70 Data	Byte71 Data
ASCII	ASCII	ASCII	ASCII	ASCII	ASCII	ASCII	ASCII	ASCII	ASCII	ASCII	ASCII

Byte72 Data	Byte73 Data	Byte74 Data	Byte75 Data	Byte76 Data	Byte77 Data	Byte78 Data	Byte79 Data	Byte80 Data	Byte81 Data
ASCII	ASCII	ASCII	ASCII	ASCII	ASCII	ASCII	ASCII	ASCII	ASCII

Example order=8: Read data values from sensor.

DATA FRAME PC → Sensor

Byte0 Header	Byte1 Header	Byte2 Header	Byte3 Header	Byte4 Header	Byte5 Header	Byte6 Header	Byte7 Header
0x55	<order>	<ARG> (lo byte)	<ARG> (hi byte)	<LEN> (lo byte)	<LEN> (hi byte)	CRC8 (Data)	CRC8 (Header)
85 (dec)	8	0	0	0	0	170	118
ARG=0				LEN=0			

DATA FRAME Sensor → PC

8 Header Bytes and all **DATA VALUES** (See Table DATA VALUE)

Example order=108: Read 3 data values from sensor.

DATA FRAME PC → Sensor

Byte0 Header	Byte1 Header	Byte2 Header	Byte3 Header	Byte4 Header	Byte5 Header	Byte6 Header	Byte7 Header	
0x55	<order>	<ARG> (lo byte)	<ARG> (hi byte)	<LEN> (lo byte)	<LEN> (hi byte)	CRC8 (Data)	CRC8 (Header)	
85 (dec)	108	0	0	0	0	170	105	
ARG=0			LEN=0					

DATA FRAME Sensor → PC

8 Header Bytes and 3 **DATA VALUES** (DatVal1, DatVal2, DatVal3. See Table DATA VALUE)

Example order=30: Start and Stop triggered sending of data frames

Start triggered sending of data frames

DATA FRAME PC → Sensor

<ARG> determines which data should be send when Trigger goes HI

ARG = 1 --> The HEADER and all DATA VALUES will be send

ARG = 2 --> The HEADER and only the color space coordinates X, Y, INT will be send

Byte0 Header	Byte1 Header	Byte2 Header	Byte3 Header	Byte4 Header	Byte5 Header	Byte6 Header	Byte7 Header	
0x55	<order>	<ARG> (lo byte)	<ARG> (hi byte)	<LEN> (lo byte)	<LEN> (hi byte)	CRC8 (Data)	CRC8 (Header)	
85 (dec)	30	1	0	0	0	170	82	
ARG=1			LEN=0					

DATA FRAME Sensor → PC

Byte0 Header	Byte1 Header	Byte2 Header	Byte3 Header	Byte4 Header	Byte5 Header	Byte6 Header	Byte7 Header	
0x55	<order>	<ARG> (lo byte)	<ARG> (hi byte)	<LEN> (lo byte)	<LEN> (hi byte)	CRC8 (Data)	CRC8 (Header)	
85 (dec)	30	1	0	0	0	170	82	
ARG=1			LEN=0					

Stop triggered sending of data frames

DATA FRAME PC → Sensor

ARG = 0 --> stops triggered sending.

Byte0 Header	Byte1 Header	Byte2 Header	Byte3 Header	Byte4 Header	Byte5 Header	Byte6 Header	Byte7 Header	
0x55	<order>	<ARG> (lo byte)	<ARG> (hi byte)	<LEN> (lo byte)	<LEN> (hi byte)	CRC8 (Data)	CRC8 (Header)	
85 (dec)	30	0	0	0	0	170	159	
ARG=0			LEN=0					

DATA FRAME Sensor → PC

Byte0 Header	Byte1 Header	Byte2 Header	Byte3 Header	Byte4 Header	Byte5 Header	Byte6 Header	Byte7 Header	
0x55	<order>	<ARG> (lo byte)	<ARG> (hi byte)	<LEN> (lo byte)	<LEN> (hi byte)	CRC8 (Data)	CRC8 (Header)	
85 (dec)	30	0	0	0	0	170	159	
ARG=0			LEN=0					

Example order=103: Start white light correction and get calibration factors, setvalue and max delta of raw data.

DATA FRAME PC → Sensor

Byte0 Header	Byte1 Header	Byte2 Header	Byte3 Header	Byte4 Header	Byte5 Header	Byte6 Header	Byte7 Header
0x55	<order>	<ARG> (lo byte)	<ARG> (hi byte)	<LEN> (lo byte)	<LEN> (hi byte)	CRC8 (Data)	CRC8 (Header)
85 (dec)	103	0	0	0	0	170	145
ARG=0				LEN=0			

DATA FRAME Sensor → PC

Byte0 Header	Byte1 Header	Byte2 Header	Byte3 Header	Byte4 Header	Byte5 Header	Byte6 Header	Byte7 Header	Byte8 Data	Byte9 Data	Byte10 Data	Byte11 Data
0x55	<order>	<ARG> (lo byte)	<ARG> (hi byte)	<LEN> (lo byte)	<LEN> (hi byte)	CRC8 (Data)	CRC8 (Header)	CF RED (lo byte)	CF RED (hi byte)	CF GREEN (lo byte)	CF GREEN (hi byte)
85 (dec)	103	0	0	10	0	212	28	228	3	223	3
ARG=0				LEN=10				CF_RED = 996		CF_GREEN = 991	

Byte12 Data	Byte13 Data	Byte14 Data	Byte15 Data	Byte16 Data	Byte17 Data
CF BLUE (lo byte)	CF BLUE (hi byte)	SET VALUE (lo byte)	SET VALUE (hi byte)	MAX DELTA (lo byte)	MAX DELTA (hi byte)
65	4	134	12	43	1
CF_BLUE = 1089		SETVALUE = 3206		MAX DELTA = 299	

Example order=105: Get cycle time from sensor

DATA FRAME PC → Sensor

Byte0 Header	Byte1 Header	Byte2 Header	Byte3 Header	Byte4 Header	Byte5 Header	Byte6 Header	Byte7 Header
0x55	<order>	<ARG> (lo byte)	<ARG> (hi byte)	<LEN> (lo byte)	<LEN> (hi byte)	CRC8 (Data)	CRC8 (Header)
85 (dec)	105	0	0	0	0	170	130
ARG=0				LEN=0			

DATA FRAME Sensor → PC

Byte0 Header	Byte1 Header	Byte2 Header	Byte3 Header	Byte4 Header	Byte5 Header	Byte6 Header	Byte7 Header	Byte8 Data	Byte9 Data	Byte10 Data	Byte11 Data
0x55	<order>	<ARG> (lo byte)	<ARG> (hi byte)	<LEN> (lo byte)	<LEN> (hi byte)	CRC8 (Data)	CRC8 (Header)	lo word lo byte	lo word hi byte	hi word lo byte	hi word hi byte
85 (dec)	105	0	0	8	0	206	163	40	28	2	0
ARG=0				LEN=8				CYCLE COUNT = 138280			

Byte12 Data	Byte13 Data	Byte14 Data	Byte15 Data
lo word lo byte	lo word hi byte	hi word lo byte	hi word hi byte
144	1	0	0
COUNTER TIME = 400			

$$\text{Cycle Time [Hz]} = \text{CYCLE COUNT} / (\text{COUNTER TIME} * 0,01)$$

$$\text{Cycle Time [ms]} = (\text{COUNTER TIME} * 0,01) / \text{CYCLE COUNT}$$

Example order=190: Write new baud rate to the sensor.

DATA FRAME PC → Sensor

Byte0 Header	Byte1 Header	Byte2 Header	Byte3 Header	Byte4 Header	Byte5 Header	Byte6 Header	Byte7 Header	
0x55	<order>	<ARG> (lo byte)	<ARG> (hi byte)	<LEN> (lo byte)	<LEN> (hi byte)	CRC8 (Data)	CRC8 (Header)	
85 (dec)	190	1	0	0	0	170	14	
ARG=1			LEN=0					

New baud rate is determined by argument.

ARG=0: baud rate = 9600

ARG=1: baud rate = 19200

ARG=2: baud rate = 38400

ARG=3: baud rate = 57600

ARG=4: baud rate = 115200

ARG=5: baud rate = 230400

ARG=6: baud rate = 460800

DATA FRAME Sensor → PC

Byte0 Header	Byte1 Header	Byte2 Header	Byte3 Header	Byte4 Header	Byte5 Header	Byte6 Header	Byte7 Header	
0x55	<order>	<ARG> (lo byte)	<ARG> (hi byte)	<LEN> (lo byte)	<LEN> (hi byte)	CRC8 (Data)	CRC8 (Header)	
85 (dec)	190	0	0	0	0	170	195	
ARG=0			LEN=0					

A. Firmware update via software Firmware Loader

A.1 Manual software Firmware Loader V1.1

This manual describes the installation of the Firmware Loader PC software and as a support for starting up the Firmware Loader software explains the individual functional elements of the graphic Windows® user interface.

The software allows the user to perform an automatic firmware update. The update will be carried out through the RS232 interface.

An initialisation file (xxx.ini) and a firmware file (xxx.elf.S) are required for performing a firmware update. These files can be obtained from your supplier. In some cases an additional firmware file for the program memory (xxx.elf.p.S) is also needed, and this file will be automatically provided together with the other two files.

Important! For a firmware update the two or three files must always be located in the same folder.

A plausibility check is performed after the initialisation file has been loaded with the Firmware Loader. If the initialisation file was changed or damaged, it will not be possible to perform a firmware update.

When the plausibility check is successfully completed, the instructions contained in the initialisation file will be carried out step by step.

The complete memory contents of the micro-controller in the sensor will be deleted in a firmware update. This means that both the program in the program memory and the data in the data memory will be lost.

The new firmware automatically writes the correct data to the program memory again.

However, the parameter settings, temperature curves, linearization curves, etc. that are stored in the data memory (EEPROM) will be deleted.

With the Firmware Loader V1.1 the data will be saved in the EEPROM, and can be written back again after successful firmware update.

For this purpose the software creates an EEPROM backup file.

A.2 Installation of the software Firmware Loader V1.1

Hardware requirements for successful installation of the Firmware Loader software:

- IBM PC AT or compatible
- VGA graphics
- Microsoft® Windows® 7, 8, 10
- Serial RS232 interface at the PC
- Microsoft® compatible mouse
- Cable ***cab-las4/PC (cab-las5/PC)*** for the RS232 interface or ***cab-4/USB (cab-5/USB)*** for USB slot or ***cab-4/ETH (cab-5/ETH)***

Please install the software as described below:

1. The software can be installed directly from the installation CD-ROM. To install the software, start the SETUP program in the INSTALL folder of the CD-ROM.
2. The installation program displays a dialog and suggests to install the software in the C:\"FILENAME" directory on the hard disk. You may accept this suggestion with **OK** or **[ENTER]**, or you may change the path as desired. Installation is then performed automatically.
3. During the installation process a new program group for the software is created in the Windows Program Manager. In the program group an icon for starting the software is created automatically. When installation is successfully completed the installation program displays "Setup OK".
4. After successful installation the software can be started with a left mouse button double-click on the icon.

Windows® is a trademark of the Microsoft Corp.
VGA™ is a trademark of the International Business Machines Corp.

Please read this chapter before you start!

In this example a software update is performed from SPECTRO3 V4.0 to SPECTRO3 V4.1.

Step 1:

When the Firmware Loader software is started, this window opens on the Windows® user interface.

Immediately after starting, the software attempts to establish a connection to the connected sensor. If the sensor should not be connected at **COM PORT 1**, please select the corresponding **COM PORT**.

Please make sure that the correct **BAUDRATE** is selected.

Now try to establish a connection by clicking on **TRY TO CONNECT**. When the connection has been established, the sensor sends back information about the current firmware.

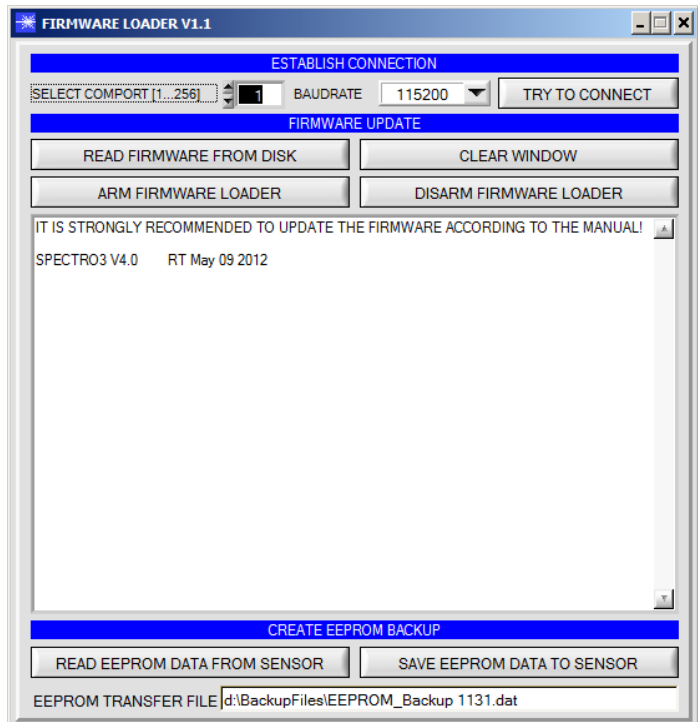

Step 2:

Press the **READ FIRMWARE FROM DISK** button and load the **xxx.ini** file.

The uploaded initialization file will be displayed in the status window.

As described above, a plausibility check of the initialisation file will be performed first.

If the file is OK, the following message will be displayed:

File read OK!

Press ARM FIRMWARE LOADER to start the firmware update.

Please read the comments that are shown in the display window. These comments allow you to make sure that you have loaded the correct initialisation file.

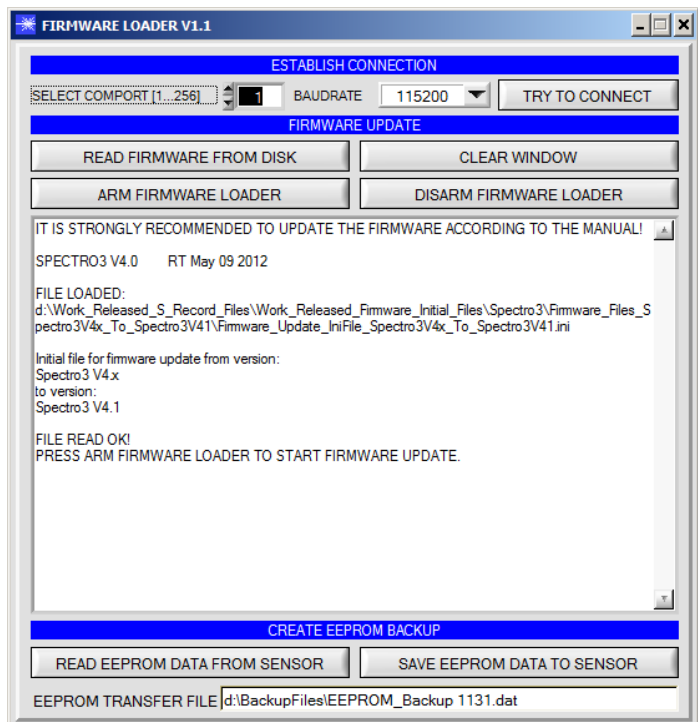

Step 3:

Now click on the **ARM FIRMWARE LOADER** button. The program now attempts to send a software command that interrupts the normal program run and jumps to the start address of the boot sector.

If this is successful, the sensor displays a prompt for loading the S-Record file to the sensor.

When you press the **ARM FIRMWARE LOADER** button the firmware update will be performed automatically.

In the course of the update process you will only be prompted to enter a name for the EEPROM backup file. If the firmware update should run perfectly until the EEPROM data are read out, but should then go wrong for any reason whatsoever, the EEPROM backup file can always be written back with **SAVE EEPROM DATA TO SENSOR**.

The file name for your **EEPROM backup file** should be chosen such that the names for several sensors cannot be mixed up. Using a file name that contains the sensor serial number might be advisable. Saving this file for future updates also might be a good idea.

After a successful update the sensor displays the status line of the new firmware.

The complete update process may take up to 1 minute.

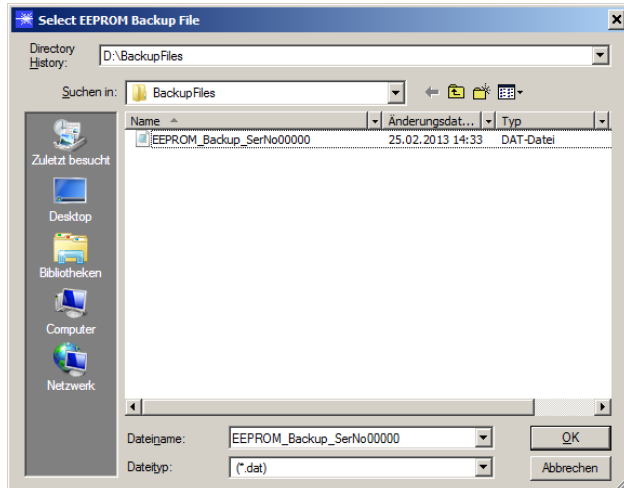
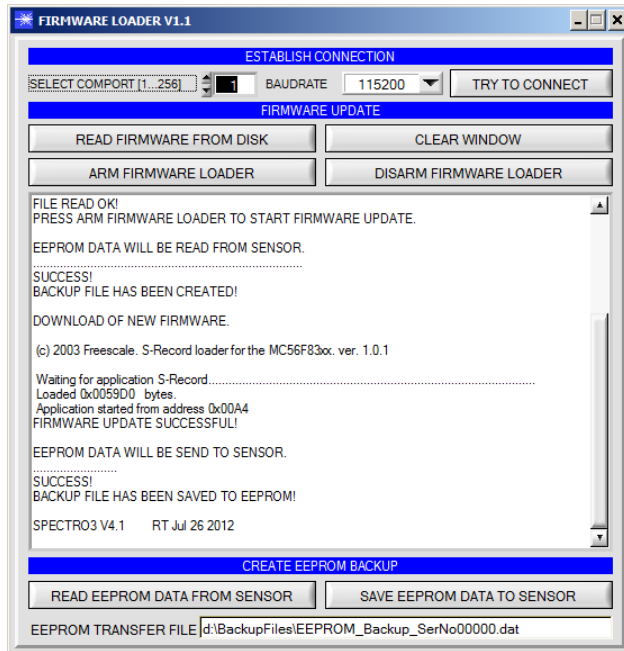

If, contrary to expectations, there should be any trouble with the update of the program memory, it will still be possible to perform an update, even though it may look like the sensor was "killed".

Please make sure that you have selected the correct **COM PORT** and the correct **BAUDRATE**.

You will not get any connection when you click on **TRY TO CONNECT**.

Load the corresponding **xxx.ini** file from the hard disk.

Then click on the **ARM FIRMWARE LOADER** button.

The program will try to send the software command for the update. This will not work, however, and you will get a **CONNECTION FAILURE** message.

However, the Firmware Loader software now is "armed" for 30 seconds.

If you perform a hardware reset within these 30 seconds, the firmware update will be performed.

After a successful update the sensor displays the status line of the new firmware.

The complete update process may take up to 1 minute.

INFO! In case that the sensor was "killed", the sensor will work with a BAUDRATE of 115200.

You may at any time create an EEPROM backup file for archiving it on your hard disk.

To do this, click on **READ EEPROM DATA FROM SENSOR**. You will be prompted to chose an initialization file in case that there has not yet been loaded any. Afterwards you will be asked to enter a file name. The selected name will be shown in the **EEPROM TRANSFER FILE** display.

The file name for your **EEPROM backup file** should be chosen such that the names for several sensors cannot be mixed up. Using a file name that contains the sensor serial number might be advisable.

The Firmware Loader then reads all the EEPROM data from the data memory and saves these data in the selected file.

Upon successful completion the following message will be displayed:

Success!
Backup File has been created!

If something should go wrong in a firmware update, any you have created the **backup file**, the saved **EEPROM backup file** can at any time be uploaded to the sensor again with **SAVE EEPROM DATA TO SENSOR**.

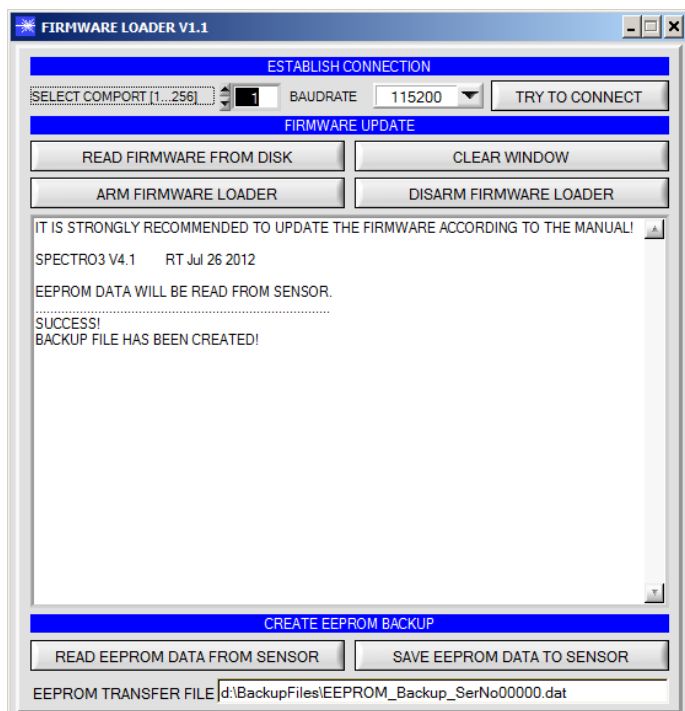
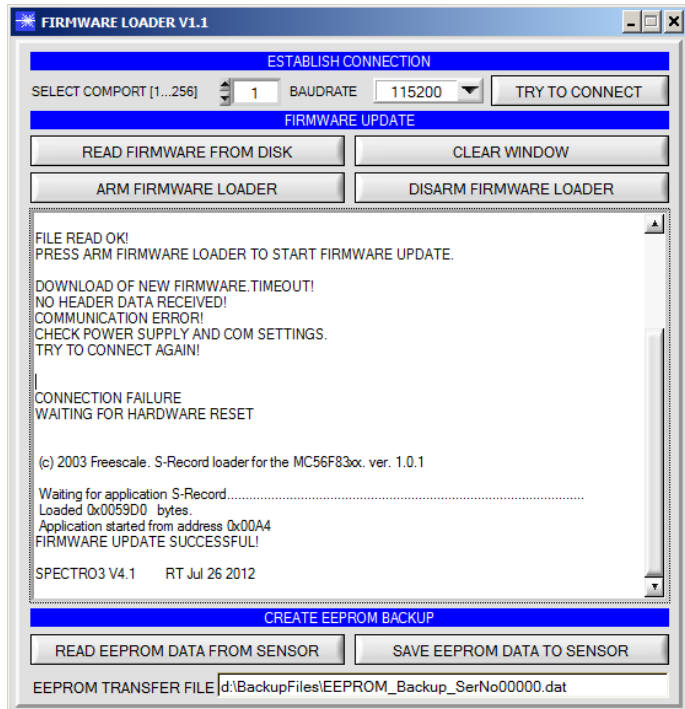

CLEAR WINDOW resets the display window.

If you should not get any response for a longer time, or if messages should be displayed in the status line, **DISARM FIRMWARE LOADER** can be used to cancel the firmware update process.

However, you should always wait for approx. 1 minute before you press this button.

