

Lynx-Eyed.

Inline Measuring Color Sensors with
D65 Similar Optical Spectrum.

Color Control and
Color Measurement

SPECTRO-3-MSM-ANA Series

Measuring True Color Sensors



Application example:

Color measurement of plastic tubes with small diameter



Color measurement of small objects such as small plastic tubes with a diameter of 1 mm or 2 mm can best be performed with a color sensor of type SPECTRO-3-FIO-MSM-ANA-VIS in combination with a wide range of fiber optics, e.g. R-S-A3.0-(3.0)-1200-Y-67°-(1P+1BP)/2P, and various frontends. This combination makes it possible to generate round light spots starting with a diameter of 0.3 mm, or rectangular lights spots starting with 1.5 mm x 0.2 mm. With a suitable fiber optics system transmission color measurement also can be realised.

Application example:

Color measurement of polished stone slabs



For determining the average color of polished stone slabs, e.g. of marble or granite, the gloss of the surface must first be compensated and must then be optically integrated to obtain an average color value of the surface. Both can be done with a color measurement sensor of type SPECTRO-3-28-45°/0°-MSM-ANA-VIS.

Application example:

Inline color measurement of plastic film

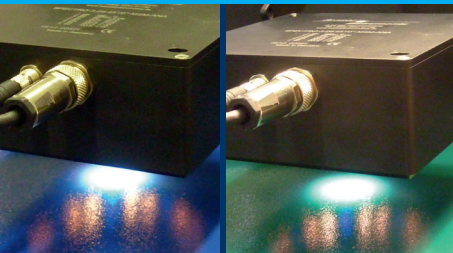

A color measurement sensor of type SPECTRO-3-28-45°/0°-MSM-ANA-VIS is used to determine the color of plastic film, because this sensor best suppresses the gloss behaviour of the film. In case of transparent film a white ceramic tile can be placed at the sensor reference distance on the side of the plastic film opposite the color sensor.

Application example:

Color measurement of glass coating



The color of coated flat glass can best be measured in direct reflection with an angled arrangement of a color measurement sensor of type SPECTRO-3-SLU-SA-MSM-ANA and a light unit of type SI-SLU-DIF-WWB-16 that provides diffuse light. The color is measured at different incidence angles, and different mounting angles are correspondingly available.

Application example:

Measurement of paper color



In the production of paper e.g. for use as packaging material the color gradient must be measured directly after coloring of the paper web. The control process is considerably facilitated by accessing the analog signals for the $L^*a^*b^*$ values. dL^* , da^* and db^* deviations can thus be reduced to a minimum in time.

Application example:

Color measurement of laminates



Laminates, as they among others are used in the furniture industry, should be inspected for their color values. The gloss behaviour should be reduced as far as possible. Since the color measurement sensor of type SPECTRO-3-28-45°/0°-MSM-ANA-VIS uses a relatively large measuring spot size, even laminates with structured surface can be reliably measured.

SPECTRO-3-MSM-ANA Series True Color Analog Color Measurement

The color sensors are equipped with LED illumination similar to the D65 standard illuminant, and with a true color RGB detector. This allows very fast color measurement in calibrated operation of up to 2.5 kHz (in AC operation independent of extraneous light). Four different measurement geometries are available: 45°/0°, diffuse/0°, fiber optics variants (through-beam and reflective), and a version with separate light unit for the color measurement of mirror surfaces. All the sensors are designed for INLINE operation and feature two digital outputs (0/+24V) and three analog outputs (0 ... +10V). Color values also can be sent through the RS232 interface with up to 460 kBaud. Because of their robust design (aluminum housing, IP67/IP64) the color measurement sensors also can be used in rough industry applications.

Windows® PC Software SPECTRO3-MSM-ANA-Scope and SPECTRO3-MSM-ANA-MONITORING

With the SPECTRO3-MSM-ANA-Scope software the color values now can be represented in the xyY, L*a*b*, L*u*v* and L*C*h* color spaces. The light modes AC, DC, and OFF also are available here. The two digital outputs of the sensor provide the information whether the current color lies in the tolerance range of a color stored in the TEACH table (max. three), and the delta E value also is displayed in the Windows® software. The three analog outputs of the color measurement sensor provide information about the values of the selected color space. In CSREF mode a color can be selected as a reference (through input IN0), the analog outputs then are centered to +5V each. By way of the ZOOM mode even the smallest color deviation can then be indicated at the analog outputs. The so-called User Calibration (UCAL) function is a new feature. With up to 64 supporting points the INLINE color measurement system can thus ideally be matched to the displayed values of a hand-held color measurement unit. With the SPECTRO3-MSM-ANA-MONITORING software the color values of up to eight color measurement sensors, together with customer-specific data as well as date and time, can be saved in a file.

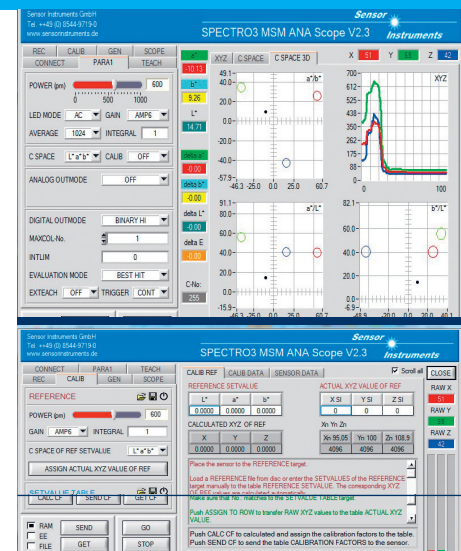
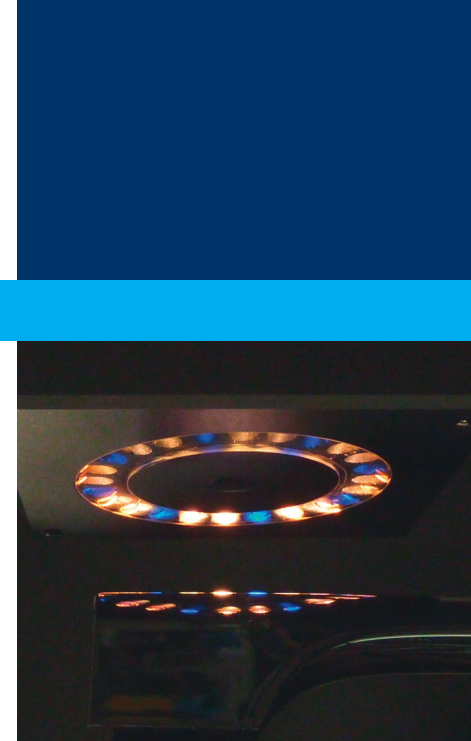

Application example:

Color measurement of painted plastic and metal parts

With the color sensor of type SPECTRO-3-28-45°/0°-MSM-ANA-VIS the color can be reliably detected even at high-gloss objects, because direct reflection of the light source used for measurement in the direction of the color detector is avoided due to the 45° light incidence angle on the surface to be measured and the consideration of the diffuse light content at 0° with respect to the normal. The ring arrangement of the light source furthermore allows high-precision color measurement of painted objects independent of the direction of rotation. Even metallic paint therefore is no problem at all.

The color of shaped objects such as painted metal rods can best be measured with a color measurement sensor of type SPECTRO-3-12-DIF-MSM-ANA-VIS with an extremely diffuse and large-area light source. Diffuse illumination ensures that direct reflection towards the color detector is suppressed.

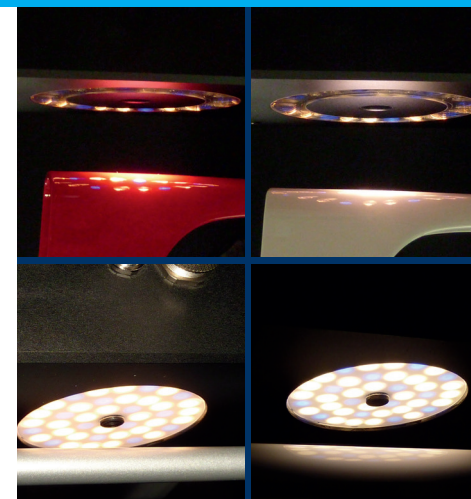

Application example:

Color measurement of glazed floor tiles and roof tiles

The color of glazed floor tiles and roof tiles can be ideally determined with a color measurement sensor of type SPECTRO-3-28-45°/0°-MSM-ANA-VIS, because the gloss effect of the surface is suppressed here as far as possible. In addition, structural differences on the surface are eliminated by using a correspondingly large measuring spot of the color measurement sensor.



SPECTRO-3-...-MSM-ANA-VIS / -VISUV

Measuring true color sensors with integrated optics

(spectral characteristics similar to D65, color space CIE L*a*b*, CIE L*C*h*, CIE L*u*v* and CIE xyY)

TYPE	CHARACTERISTICS	OBJECTDISTANCE (TYP.)	DETECTION RANGE (AT DISTANCE, TYP.)	DIMENSIONS (LxWxH IN MM)	LIGHT SOURCE (TRANSMITTER)	RECEIVER	MEAS. ACCURACY, RESOLUTION	SCAN FREQUENCY	COLOR MEMORY	INPUTS/ OUTPUTS	SOFTWARE/ INTERFACE
SPECTRO-3-12-DIF-MSM-ANA-VIS	Reduction of gloss effect due to diffuse illumination (volume lens serves as a diffuser, for optimal scattering effect)	12 mm ± 1 mm	5 mm (12 mm)	80 x 80 x 42.5	28x warm white LED, diffuse + interference filter, 14x blue-light LED	RGB detector: True Color detector, "human color reception". Color filter curves acc. to CIE1931	Measurement accuracy: typ. $\Delta E = 0.3$ Resolution: $\Delta E = 0.01$	AC operation: max. 25 kHz DC operation: max. 90 kHz OFF operation: max. 90 kHz	Non-volatile EEPROM with parameter sets for max. 3 colors	1x digital input: IN0 (0/+24V) 2x digital output: OUT0, OUT1 (0/+24V), npn-/pnp-able 3x analog output: OUT2 ... OUT4 (0 ... +10V)	SPECTRO3-MSM-ANA-Scope, SPECTRO3-MSM-ANA-MONITORING, RS232 (USB- and Ethernet adaptor available)
SPECTRO-3-12-DIF-MSM-ANA-VISUV					24x warm white LED, diffuse + interference filter, 12x blue-light LED, 6x UV LED						
SPECTRO-3-28-45°/0°-MSM-ANA-VIS	Color control to 45°/0° method (45° transmitter arrangement, 0° receiver arrangement)	28 mm ± 2 mm	10 mm (28 mm)	100 x 100 x 40	16x warm white LED + interference filter, 8x blue-light LED						
SPECTRO-3-28-45°/0°-MSM-ANA-VISUV					12x warm white LED + interference filter, 8x blue-light LED, 4x UV-LED						
GENERAL TECHNICAL DATA	Voltage supply: +24VDC (±10%). Current consumption: <1.2 A. Transmitter control: LED mode can be switched via PC software (AC, DC or OFF operation). Max. switching current: 100 mA, short circuit proof. Switching frequency: typ. 60 kHz. Analog band width: max. 90 kHz (-3dB). Encl. rating: IP64. Housing material: Aluminum, anodized in black. Operating temperature range: -20°C...+55°C. EMC test acc. to: DIN EN 60947-2.										

Illustrations

Dimensions in mm

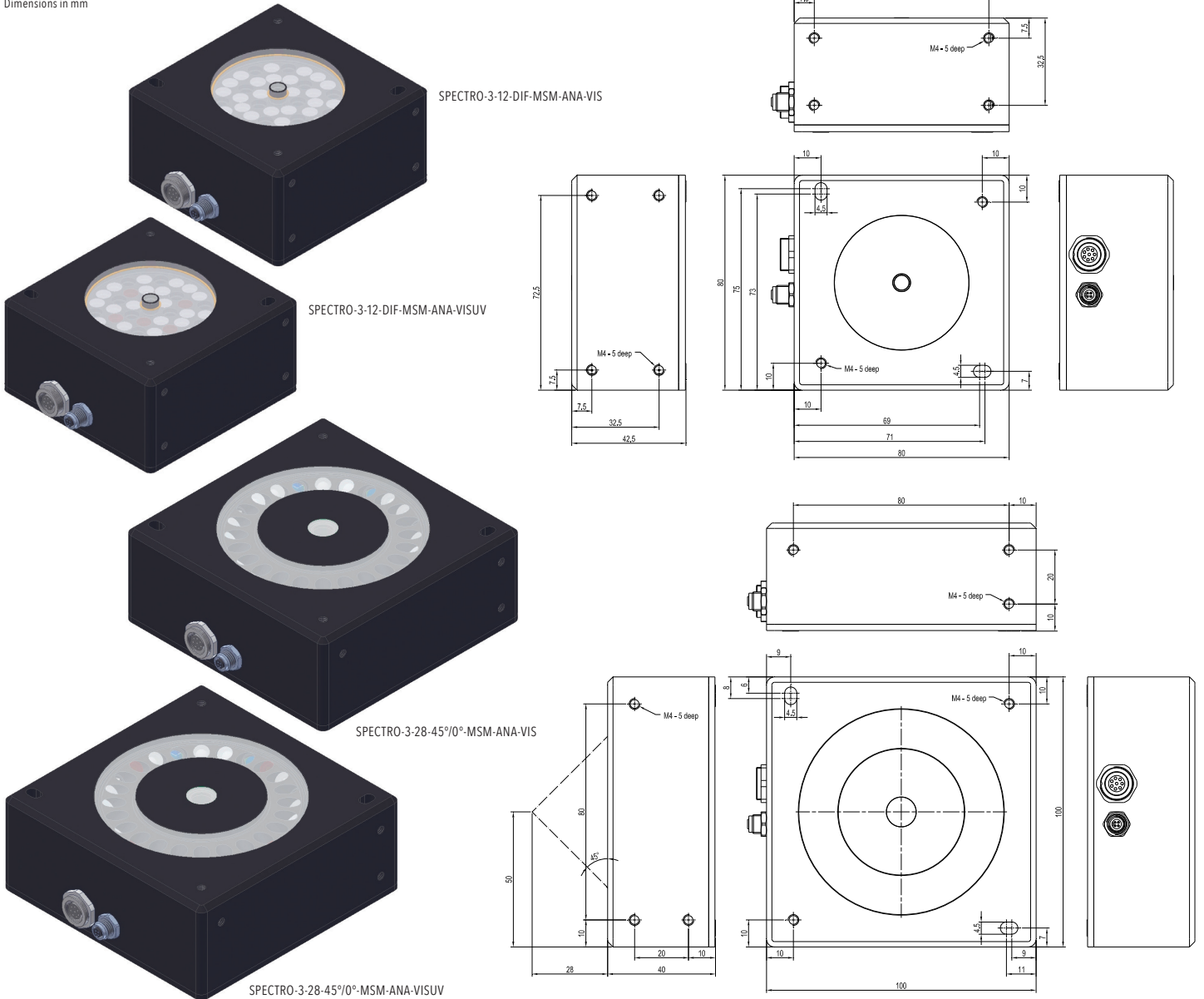

ACCESSORIES For SPECTRO-3-12-DIF-MSM-ANA-VIS / -VISUV: Spacer SPECTRO-3-12-DIF-OFL.
For SPECTRO-3-28-45°/0°-MSM-ANA-VIS / -VISUV: Calibration device SPECTRO-3-28-45°/0°-CAL. Spacer SPECTRO-3-28-45°/0°-OFL or SPECTRO-3-28-45°/0°-OFL-D30.

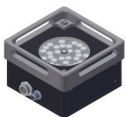

SPECTRO-3-12-DIF-MSM-ANA-VIS / -VISUV

+ SPECTRO-3-12-DIF-OFL

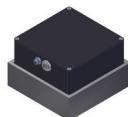

SPECTRO-3-28-45°/0°-MSM-ANA-VIS / -VISUV

+ SPECTRO-3-28-45°/0°-CAL

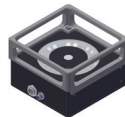

SPECTRO-3-28-45°/0°-MSM-ANA-VIS / -VISUV

+ SPECTRO-3-28-45°/0°-OFL

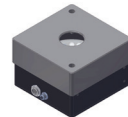

SPECTRO-3-28-45°/0°-MSM-ANA-VIS / -VISUV

+ SPECTRO-3-28-45°/0°-OFL-D30

SPECTRO-3-SLU-SA-MSM-ANA + SI-SLU-DIF-WWB-16

Measuring true color sensors with external lighting unit

(spectral characteristics similar to D65, color space CIE L*a*b*, CIE L*C*h*, CIE L*u*v* and CIE xyY)

TYPE	CHARACTERISTICS	OBJECTDISTANCE (TYP.)	SIZE OF LIGHT SPOT	DIMENSIONS (LxWxH IN MM)	LIGHT SOURCE (TRANSMITTER)	RECEIVER	MEAS. ACCURACY, RESOLUTION	SCAN FREQUENCY	COLOR MEMORY	INPUTS/ OUTPUTS	SOFTWARE/ INTERFACE
SPECTRO-3-SLU-SA-MSM-ANA + SI-SLU-DIF-WWB-16	Split design: Electronic control unit (receiver) and external lighting unit (transmitter)	Reflected light operation: up to max. 100 mm Transmitted light operation: max. 100 mm	Depends on position of the transmitter to the measuring object	65 x 65 x 26 (each receiver and transmitter)	10x warm white LED, diffuse 6x blue light LED	RGB detector: True Color detector, "human color reception". Color filter curves acc. to CIE1931	Measurement accuracy: typ. $\Delta E = 0.3$ Resolution: $\Delta E = 0.01$	AC operation: max. 25 kHz DC operation: max. 90 kHz OFF operation: max. 90 kHz	Non-volatile EEPROM with parameter sets for max. 3 colors	1x digital input: IN0 (0/+24V) 2x digital output: OUT0, OUT1 (0/+24V), npn-/pnp-able 3x analog output: OUT2 ... OUT4 (0 ... +10V)	SPECTRO3-MSM-ANA-Scope, SPECTRO3-MSM-ANA-MONITORING, RS232 (USB- and Ethernet adaptor available)
GENERAL TECHNICAL DATA	Voltage supply: +24VDC ($\pm 10\%$). Current consumption: <300 mA. Transmitter control: LED mode can be switched via PC software (AC, DC or OFF operation). Max. switching current: 100 mA, short circuit proof. Switching frequency: typ. 60 kHz. Analog band width: max. 90 kHz (-3dB). Encl. rating: IP67/IP64. Housing material: Aluminum, anodized in black. Operating temperature range: -20°C...+55°C. EMC test acc. to: DIN EN 60947-2.										

Illustrations

Dimensions in mm

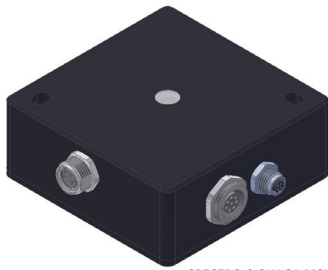

SPECTRO-3-SLU-SA-MSM-ANA
(Electronic control unit/receiver)

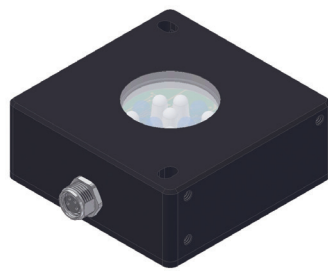
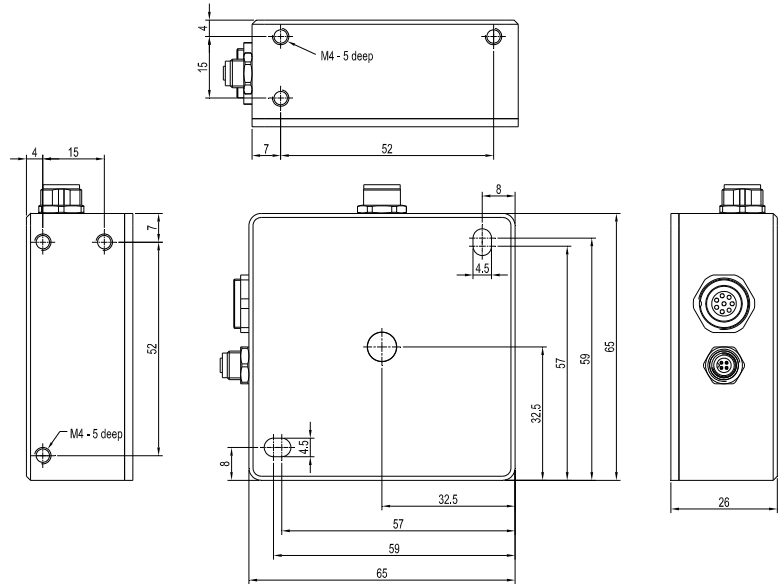

SI-SLU-DIF-WWB-16
(Side light unit/transmitter)

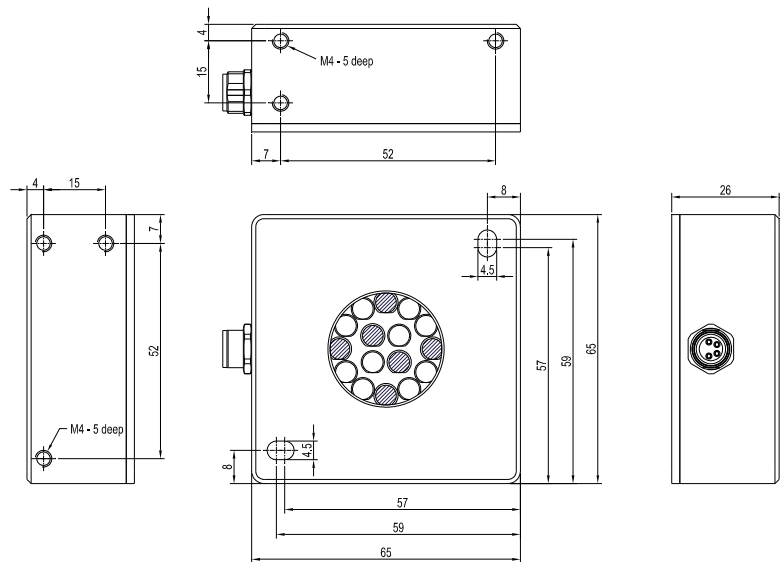

ACCESSORIES

Mounting brackets for reflected light operation: MOUNT-SLU-10°/10°-210, MOUNT-SLU-20°/20°-100, MOUNT-SLU-45°/45°-55, MOUNT-SLU-60°/60°-55.
Mounting brackets for transmitted light operation: MOUNT-SLU-80/200, MOUNT-SLU-80/500.

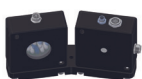

SPECTRO-3-SLU-SA-MSM-ANA + SI-SLU-DIF-WWB-16

+ MOUNT-SLU-10°/10°-210

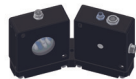

SPECTRO-3-SLU-SA-MSM-ANA + SI-SLU-DIF-WWB-16

+ MOUNT-SLU-20°/20°-100

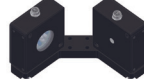

SPECTRO-3-SLU-SA-MSM-ANA + SI-SLU-DIF-WWB-16

+ MOUNT-SLU-45°/45°-55



SPECTRO-3-SLU-SA-MSM-ANA + SI-SLU-DIF-WWB-16

+ MOUNT-SLU-60°/60°-55

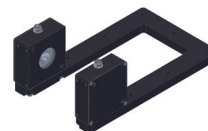

SPECTRO-3-SLU-SA-MSM-ANA + SI-SLU-DIF-WWB-16

+ MOUNT-SLU-80/200



SPECTRO-3-SLU-SA-MSM-ANA + SI-SLU-DIF-WWB-16

+ MOUNT-SLU-80/500

SPECTRO-3-FIO-MSM-ANA-VIS / -VISUV

Measuring true color sensors for operation with optical fibers

(spectral characteristics similar to D65, color space CIE L*a*b*, CIE L*C*h*, CIE L*u*v* and CIE xyY)

TYPE	CHARACTERISTICS	OBJECT DISTANCE (TYP.)	SIZE OF LIGHT SPOT	DIMENSIONS (LxWxH IN MM)	LIGHT SOURCE (TRANSMITTER)	RECEIVER	MEAS. ACCURACY, RESOLUTION	SCAN FREQUENCY	COLOR MEMORY	INPUTS/OUTPUTS	SOFTWARE/INTERFACE
SPECTRO-3-FIO-MSM-ANA-VIS	2 fiber optics adaptors for connection of transmitter fiber optics and receiver fiber optics	Reflected light operation: 1 mm ... 500 mm Transmitted light operation: 10 mm ... 500 mm	Depends on fiber optics and optical frontend	80 x 70 x 36	LEDs similar to D65 and interference filter	RGB detector: True Color detector, "human color reception". Color filter curves acc. to CIE1931	Measurement accuracy: typ. $\Delta E = 0.3$ Resolution: $\Delta E = 0.01$	AC operation: max. 25 kHz DC operation: max. 90 kHz OFF operation: max. 90 kHz	Non-volatile EEPROM with parameter sets for max. 3 colors	1x digital input: I/O (0/+24V) 2x digital output: OUT0, OUT1 (0/+24V), npn-/pnp-able 3x analog output: OUT2 ... OUT4 (0 ... +10V)	SPECTRO3-MSM-ANA-Scope, SPECTRO3-MSM-ANA-MONITORING, RS232 (USB- and Ethernet adaptor available)
SPECTRO-3-FIO-MSM-ANA-VISUV	2 fiber optics adaptors for connection of transmitter fiber optics and receiver/transmitter fiber optics	V light operation: 10 mm ... 300 mm (depends on fiber optics and optical frontend)			D65 similar light due to suitable warm white LEDs and interference filter, deep blue LEDs as well as UV-LEDs						
GENERAL TECHNICAL DATA	Voltage supply: +24VDC ($\pm 10\%$). Current consumption: <160 mA. Transmitter control: LED mode can be switched via PC software (AC, DC or OFF operation). Max. switching current: 100 mA, short circuit proof. Switching frequency: typ. 60 kHz. Analog band width: max. 90 kHz (-3dB). Encl. rating: IP64. Housing material: Aluminum, anodized in black. Operating temperature range: -20°C ... +55°C. EMC test acc. to: DIN EN 60947-2.										

Illustrations

Dimensions in mm

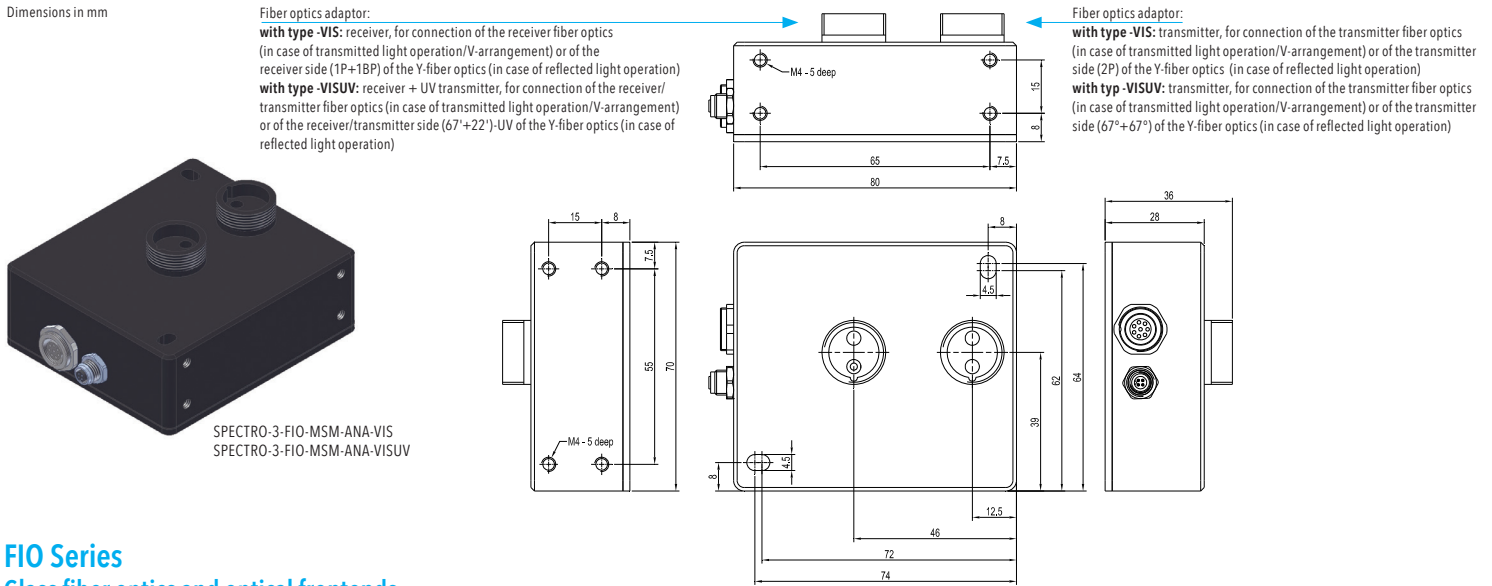

FIO Series

Glass fiber optics and optical frontends

(for SPECTRO-3-FIO-MSM-ANA-VIS / -VISUV)

SUITABLE FIBER OPTICS FOR SPECTRO-3-FIO-MSM-VIS	FIBER OPTICS SENSOR HEAD TYPES A2.0 AND A3.0 (DIMENSIONS IN MM)																																																		
Fiber optics (1x transmitter and 1x receiver fiber optics) for transmitted light operation or V-arrangement: Transmitter fiber optics R-S-A2.0-(0.6)-1200-67° and receiver fiber optics R-S-A2.0-(2.5)-1200-67°-(1P+1BP) or Transmitter fiber optics R-S-A2.0-(1.0)-1200-67° and receiver fiber optics R-S-A2.0-(2.5)-1200-67°-(1P+1BP) or Transmitter fiber optics R-S-A2.0-(1.5)-1200-67° and receiver fiber optics R-S-A2.0-(2.5)-1200-67°-(1P+1BP) or Transmitter fiber optics R-S-A2.0-(2.5)-1200-67° and receiver fiber optics R-S-A2.0-(2.5)-1200-67°-(1P+1BP) or Transmitter fiber optics X-S-A2.0-(2.5)-1200-67° and receiver fiber optics R-S-A2.0-(2.5)-1200-67°-(1P+1BP) or Transmitter fiber optics R-S-A3.0-(3.0)-1200-67° and receiver fiber optics R-S-A3.0-(3.0)-1200-67°-(1P+1BP)	Sensor head type A <table border="1"> <thead> <tr> <th>Variant</th> <th>ØA</th> <th>B</th> <th>C</th> <th>D</th> <th>ØE</th> <th>ØF</th> <th>ØJ with sheath type S</th> <th>End sleeve</th> </tr> </thead> <tbody> <tr> <td>A2.0-(0.6)</td> <td>6.6</td> <td>10</td> <td>2</td> <td>12</td> <td>4.5</td> <td>0.6</td> <td>5.8</td> <td rowspan="5">Stainless steel</td> </tr> <tr> <td>A2.0-(1.0)</td> <td>6.6</td> <td>10</td> <td>2</td> <td>12</td> <td>4.5</td> <td>1.0</td> <td>5.8</td> </tr> <tr> <td>A2.0-(1.5)</td> <td>6.6</td> <td>10</td> <td>2</td> <td>12</td> <td>4.5</td> <td>1.5</td> <td>5.8</td> </tr> <tr> <td>A2.0-(2.5)</td> <td>6.6</td> <td>10</td> <td>2</td> <td>12</td> <td>4.5</td> <td>2.5</td> <td>5.8</td> </tr> <tr> <td>A3.0-(3.0)</td> <td>8.5</td> <td>11</td> <td>2</td> <td>15</td> <td>6</td> <td>3</td> <td>7.5</td> </tr> </tbody> </table>	Variant	ØA	B	C	D	ØE	ØF	ØJ with sheath type S	End sleeve	A2.0-(0.6)	6.6	10	2	12	4.5	0.6	5.8	Stainless steel	A2.0-(1.0)	6.6	10	2	12	4.5	1.0	5.8	A2.0-(1.5)	6.6	10	2	12	4.5	1.5	5.8	A2.0-(2.5)	6.6	10	2	12	4.5	2.5	5.8	A3.0-(3.0)	8.5	11	2	15	6	3	7.5
Variant	ØA	B	C	D	ØE	ØF	ØJ with sheath type S	End sleeve																																											
A2.0-(0.6)	6.6	10	2	12	4.5	0.6	5.8	Stainless steel																																											
A2.0-(1.0)	6.6	10	2	12	4.5	1.0	5.8																																												
A2.0-(1.5)	6.6	10	2	12	4.5	1.5	5.8																																												
A2.0-(2.5)	6.6	10	2	12	4.5	2.5	5.8																																												
A3.0-(3.0)	8.5	11	2	15	6	3	7.5																																												
Fiber optics (1x Y-fiber optics) for reflected light operation: Y-fiber optics R-S-A2.0-(2.5)-1200-Y-67°-(1P+1BP)/2P or Y-fiber optics R-S-A3.0-(3.0)-1200-Y-67°-(1P+1BP)/2P	FIBER OPTICS INTEGRATED IN OPTICAL FRONTENDS TYPE KL-D-0°/45°-85-1200-...-VIS OR KL-D-0°/45°-85-1200-...-VISUV Optical frontend with integrated fiber optics for color sensor SPECTRO-3-FIO-MSM-VIS: KL-D-0°/45°-85-1200-A2.0-VIS incl. transmitter fiber optics R-S-A2.0-(2.5)-1200-67° and receiver fiber optics R-S-A2.0-(2.5)-1200-67°-(1P+1BP) KL-D-0°/45°-85-1200-A3.0-VIS incl. transmitter fiber optics R-S-A3.0-(3.0)-1200-67° and receiver fiber optics R-S-A3.0-(3.0)-1200-67°-(1P+1BP) Optical frontend with integrated fiber optics for color sensor SPECTRO-3-FIO-MSM-VISUV: KL-D-0°/45°-85-1200-A2.0-VISUV incl. transmitter fiber optics R-S-A2.0-(2.5)-1200-67° and receiver/transmitter fiber optics R-S-A2.0-(2.5)-1200-67°/22°-UV KL-D-0°/45°-85-1200-A3.0-VISUV incl. transmitter fiber optics R-S-A3.0-(3.0)-1200-67° and receiver/transmitter fiber optics R-S-A3.0-(3.0)-1200-67°/22°-UV																																																		
SUITABLE FIBER OPTICS FOR SPECTRO-3-FIO-MSM-VISUV Fiber optics (1x transmitter and 1x receiver/transmitter fiber optics) for transmitted light operation or V-arrangement: Transmitter fiber optics R-S-A2.0-(2.5)-1200-67° and receiver/transmitter fiber optics R-S-A2.0-(2.5)-1200-67°/22°-UV or Transmitter fiber optics R-S-A3.0-(3.0)-1200-67° and receiver/transmitter fiber optics R-S-A3.0-(3.0)-1200-67°/22°-UV Fiber optics (1x Y-fiber optics) for reflected light operation: Y-fiber optics R-S-A2.0-(2.5)-1200-Y-(67°+67°)/(67°+22°)-UV or Y-fiber optics R-S-A3.0-(3.0)-1200-Y-(67°+67°)/(67°+22°)-UV																																																			

R-S-A2.0-(x.x)*-1200-67°
 R-S-A2.0-(2.5)-1200-67°-(1P+1BP)
 R-S-A2.0-(2.5)-1200-67°/22°-UV
 *(x.x) = (0.6) / (1.0) / (1.5) / (2.5)

R-S-A3.0-(3.0)-1200-67°
 R-S-A3.0-(3.0)-1200-67°-(1P+1BP)
 R-S-A3.0-(3.0)-1200-67°/22°-UV

X-S-A2.5-(2.5)-1200-67°
 X-S-A3.0-(3.0)-1200-67° (ähnlich)



FIO Series

Glass fiber optics and optical frontends (for SPECTRO-3-FIO-MSM-ANA-VIS / -VISUV)

FIBER OPTICS DESIGN

Transmitter fiber optics (for type -VIS / -VISUV)

R-S-A2.0-(x.x)*-1200-67°
 R-S-A3.0-(3.0)-1200-67° (similar)
 *(x.x) = (0.6)/(1.0)/(1.5)/(2.5)

Receiver fiber optics (for type -VIS)

R-S-A2.0-(2.5)-1200-67°-(1P+1BP)
 R-S-A3.0-(3.0)-1200-67°-(1P+1BP) (similar)

Receiver/transmitter fiber optics (for type -VISUV)

R-S-A2.0-(2.5)-1200-67°/22°-UV
 R-S-A3.0-(3.0)-1200-67°/22°-UV (similar)
 UV fibers with opening angle 22° instead of the blind pin

Transmitter fiber optics (for type -VIS)

X-S-A2.0-(2.5)-1200-67°
 X-S-A3.0-(3.0)-1200-67° (similar)

Y-fiber optics (for type -VIS)

R-S-A2.0-(2.5)-1200-Y-67°-(1P+1BP)/2P
 R-S-A3.0-(3.0)-1200-Y-67°-(1P+1BP)/2P (similar)

Y-fiber optics (for type -VISUV)

R-S-A2.0-(2.5)-1200-Y-(67°+67°)/(67°+22°)-UV (similar)
 R-S-A3.0-(3.0)-1200-Y-(67°+67°)/(67°+22°)-UV

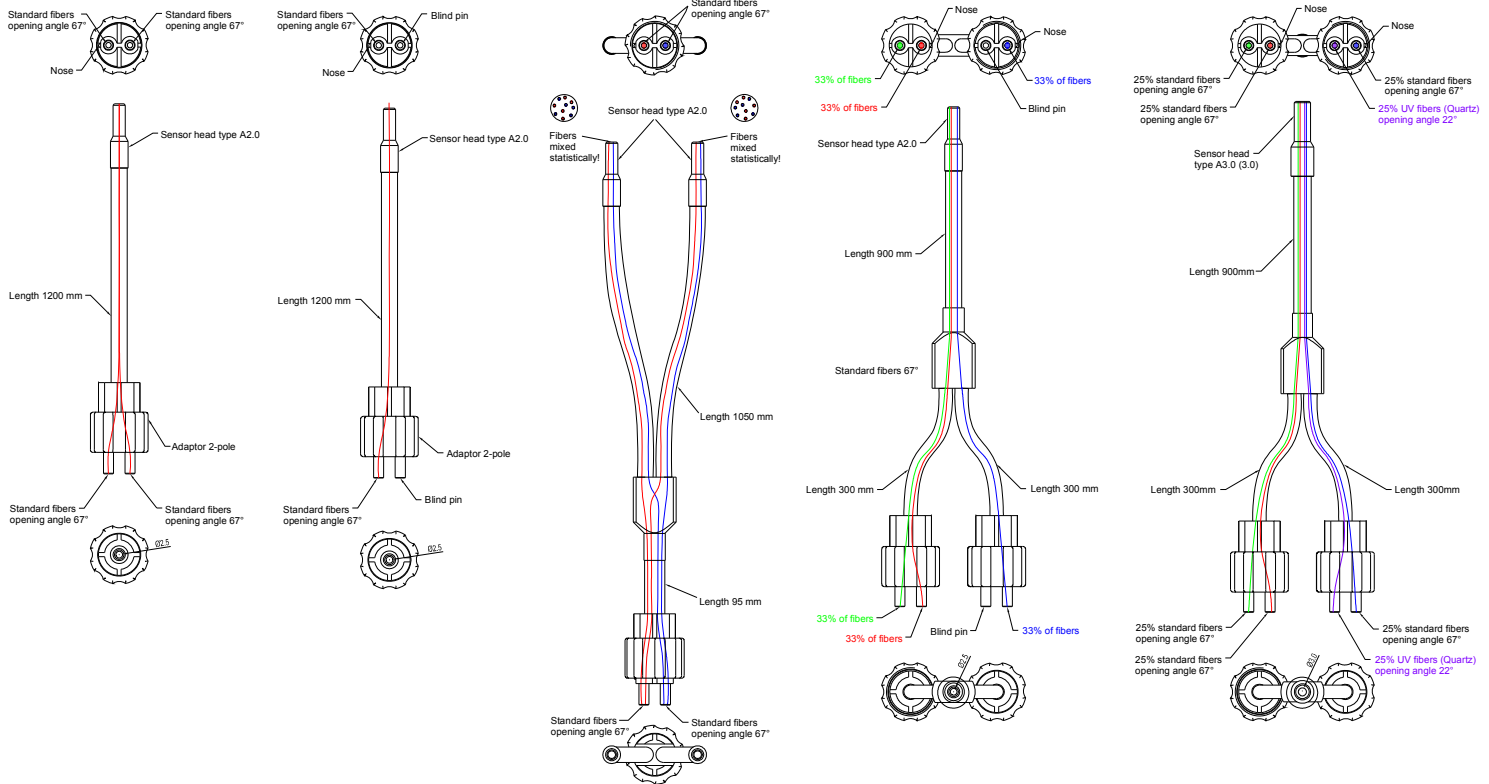

OPTICAL FRONTENDS (KL-D-...) AND MOUNTING DEVICES (MOUNT-...) FOR FIBER OPTICS WITH SENSOR HEAD TYPE A2.0 OR A3.0

Illustrations

Dimensions in mm

KL-D-0°/45°-85-1200-A2.0-VIS
 KL-D-0°/45°-85-1200-A3.0-VIS
 KL-D-0°/45°-85-1200-A2.0-VISUV
 KL-D-0°/45°-85-1200-A3.0-VISUV
 (je mit integrierten Lichtleitern)

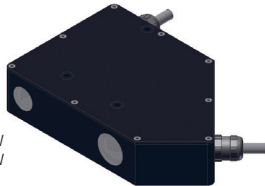

KL-D-0°/45°-30-A2.0
 KL-D-0°/45°-30-A3.0

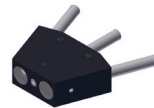

KL-D-DIF-5-A2.0
 KL-D-DIF-5-A3.0

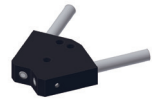

MOUNT-A2.0-45°/10
 MOUNT-A3.0-45°/10

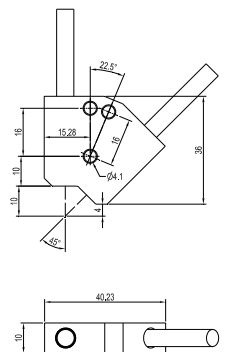
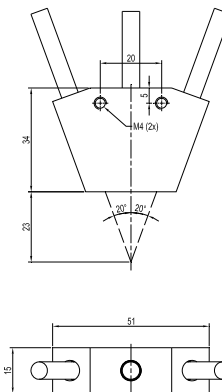
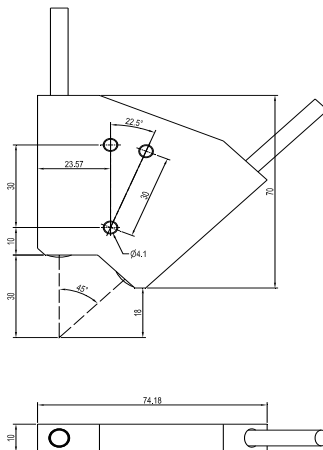
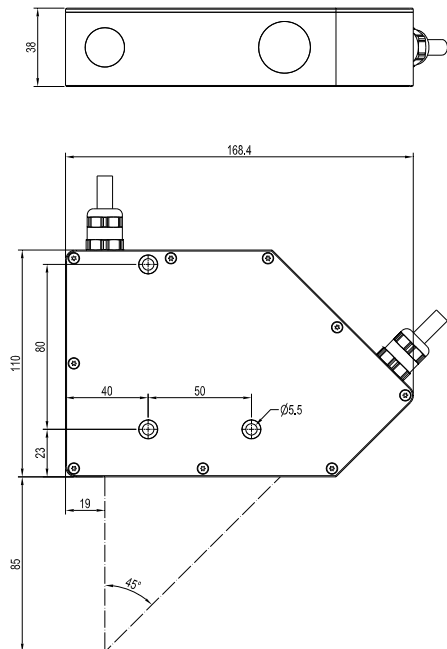

Sensor



Let's make sensors more individual

Instruments

Manufacturer

Sensor Instruments Entwicklungs- und Vertriebs GmbH
Schlinding 11
D-94169 Thurmansbang/Germany
Phone +49 (0) 8544.97 19-0
Fax +49 (0) 8544.97 19-13
info@sensorinstruments.de
www.sensorinstruments.de

Our product lines:



**Color Control and
Color Measurement**



**Distance Measurement
and Positioning**



**Surface Inspection
and Counting**



**Product Marking and
Product Tracking**



**Fiber Optics and
Accessories**



**Individual
Sensor Systems**

Presented by



For contact details please see www.sensorinstruments.de